



PUBLIC WORKS DEPARTMENT

Wastewater Utility

2009 Radcliffe Road

Juneau, Alaska 99801

Phone: 907.586.0393 Fax: 907.789.1681

Samantha_Stoughtenger@ci.juneau.ak.us

DATE: October 28, 2014

TO: Mr. Michael Satre, Chair
Planning Commission

FROM: Samantha Stoughtenger, PE - Wastewater Utility Superintendent
Michele Elfers - Engineering Department

RE: Biosolids Treatment and Disposal Evaluation, Phase II Update

Please find attached the memorandum and report presented at the October 6, 2014 meeting of the CBJ Committee of the Whole (COW). The presentation given by staff at the Planning Commission COW meeting will include the same information as was presented at the COW meeting.

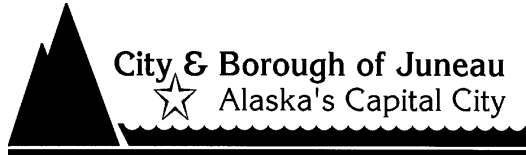

City and Borough of Juneau

Engineering Department

155 South Seward Street

Juneau, Alaska 99801

Telephone: 586-0800 Facsimile: 463-2606

DATE: October 6, 2014

TO: Assembly Committee of the Whole

FROM: Michele Elfers - Engineering Department
Samantha Stoughtenger, PE - Wastewater Utility Superintendent

RE: Biosolids Treatment and Disposal Evaluation, Phase II Update

In response to concern over the long-term stability of shipping biosolids to Oregon, the CBJ has performed an evaluation of viable treatment and disposal alternatives for biosolids. Biosolids are the semi-solid organic materials resulting from the treatment of sewage sludge. From 1992 to 2010, an incinerator located at the Juneau Douglas Wastewater Treatment Plant (JDWWTP) effectively combusted our biosolids to produce an inert ash that was disposed of onsite. In 2010, the incinerator was decommissioned due primarily to corrosion issues after performing for its expected lifespan of 20 years. The cost of repair, estimated at \$2 Million, was considered too expensive to pay to extend the service life. Instead, the CBJ worked with Waste Management (WM) to handle our biosolids. WM first disposed of the biosolids at the local landfill but discontinued this after a few months due to complaints of a significant increase of odors by the public. WM then began shipping the biosolids to Oregon for disposal in a landfill while other alternatives were considered by the CBJ. The cost per wet ton to the CBJ for biosolid disposal at the local landfill in 2010 was \$88. The cost to ship the biosolids to Oregon in 2013 was \$140/wet ton. The current cost to ship the biosolids under the contract with WM to Oregon is \$215/wet ton.

Since the incinerator was decommissioned, rising fuel costs, uncertainty over environmental regulations in Oregon, and issues with odors and leaking containers that threatened the CBJ – WM contract, have become real and immediate threats to the long term viability of this disposal strategy. If the contract is terminated, the CBJ would be in an emergency situation with no method for disposal of the biosolids, posing a significant health hazard for the community.

CBJ hired a consultant, CH2M Hill, to evaluate selected alternatives and recommend a treatment and disposal system. This evaluation has been completed and is attached to this memo. The recommended alternative is a thermal belt dryer that circulates hot air to dry the sludge and produces pellets. The pellets would be combusted in a furnace; the heat generated from this process would return to the belt dryer to dry the biosolids. Some supplemental fuel in the form of oil or wood pellets would be required for the process. The dried pellets from the thermal dryer could alternatively be used as a soil amendment.

The JDWWTP is the recommended location based on air permit considerations, available land and infrastructure, and distance from incompatible land uses. However, capital investment and O&M costs for siting the facility at JDWWTP are higher than if the new facility were to be located at the Mendenhall Wastewater Treatment Plant. The planning-level capital construction cost for the dryer/furnace at the JDWWTP is \$28.7 Million. The approximate annual cost for disposal of biosolids would be \$664,000 compared with the current disposal costs of \$2 Million.

Pending approval, funding for the new facility is anticipated to come from revenue bonds and grants to be applied for in the next year. If funding is secured in 2015, construction could begin in 2016.

Final Report

Biosolids Treatment and Disposal Evaluation – Phase II

Prepared for
City and Borough of Juneau

September, 2014

CH2MHILL®

949 East 36th Avenue
Suite 500
Anchorage, AK 99508

Contents

Section	Page
Executive Summary	
1.1	Project Goals and Objectives Accomplished..... 1
1.2	Design and Evaluation Criteria..... 1
1.3	Results of Alternatives Evaluation 3
1.4	Recommended Operating Strategy 6
1.5	Recommended Project Delivery Method 7
Tables	
ES-1	Design Criteria for CBJ’s Solids Management Alternatives..... 2
ES-2	Non-Monetary Criteria and Weightings Used in Alternatives Evaluation 3
ES-3	Net Present Value (NPV) Cost Estimates of the Alternatives for MWWTP Facility Location 5
ES-4	Net Present Value (NPV) Cost Estimates of the Alternatives for JDWWTP Facility Location 5
ES-5	Anticipated Project Schedule under Option 1: Construction of Drying and Heat-Recovery Systems in a Single Capital Project 7
ES-6	Anticipated Project Schedule under Option 2: Construction of Drying and Heat-Recovery Systems in a Single Capital Project using Progressive Design-Build Delivery Approach..... 8
Figures	
ES-1	Stacked Bar Chart Display of Non-monetary Criteria Rankings of Alternatives 1-4 4
ES-2	Benefit-Cost Scores for All Alternatives Relative to Status Quo Option for MWWTP Facility Location .5
ES-3	Benefit-Cost Scores for All Alternatives Relative to Status Quo Option for JDWWTP Facility Location.6
TM 1 - Data Review & Regulatory Conditions and Outlook	
1.1	Introduction 1
2.1	Summary of Information Received to Date 1
3.1	Review of Solids Production Data 3
3.2	Review of Solids Characteristics and Analytical Results 5
4.1	Review of Pertinent Federal Regulations..... 6
4.1.1	40 CFR Part 503 Subpart B: Land Application 7
4.1.2	40 CFR Part 503 Subpart C: Surface Disposal..... 8
4.1.3	40 CFR Part 503 Subpart D: Pathogen and Vector Attraction Reduction 9
4.1.4	40 CFR Part 503 Subpart E: Incineration 11
4.2	Predicted Changes to Federal Part 503 Regulation and their Potential Impacts 11
5.1	Review of Pertinent State and Local Regulations 12
5.1.1	State Disposal Regulations..... 12
5.1.2	End Uses..... 13
5.1.3	State Air Regulations..... 13
5.1.4	Local Requirements: 14
6.1	Suggested Design Criteria for Biosolids Handling Facility 15
6.1.1	Proposed Solids Projections..... 15
7.1	Summary and Conclusions..... 16
7.2	Path Forward..... 18

Tables

1 Summary of Documents and Historical Data provided by CBJ to CH2M HILL related to Biosolids Study 2

2 2013 Solids Production from CBJ’s MWWTP and JDWWTP, plus Combined Totals 3

3 Comparison of EPA Part 503 Pollutant Ceiling Limits and “Exceptional Quality” Pollutant Concentration Limits with Results of Recent Solids Analyses from JDWWTP and MWWTP 5

4 Results of Other Constituents of Interest from Recent Solids Analyses from JDWWTP and MWWTP . 6

5 Pathogen Reduction Requirements from 40 CFR Part 503 Rule 9

6 Minor Air Permit Limits 14

7 Proposed General Design Criteria for Purpose of Developing Solids Management Alternatives..... 15

Figures

1 Total Monthly Solids Production from CBJ’s MWWTP and JDWWTP in 2013..... 4

2 Evaluation Criteria and Weightings to be Used in Biosolids Alternatives Analysis 17

TM 2 - Alternatives Evaluation and Results

1.1 Introduction..... 1

2.1 Solids Loading Projections, Characteristics, and Design Conditions 1

3.1 Description of Alternatives 3

3.1.1 Alternative 1 - Continuing the Transport and Landfilling of Dewatered Biosolids 4

3.1.2 Alternative 2 - Thermal Drying Technology..... 5

3.1.3 Alternative 3 - Thermal Drying followed by Incineration for Heat Recovery 6

3.1.4 Alternative 4 – New Fluidized Bed Incinerator..... 9

4.1 Alternatives Evaluation 9

4.1.1 Review of Evaluation Criteria, Weighting, and Ranking 9

4.1.2 Carbon Footprint Estimates and Comparisons between Alternatives 10

4.1.3 Non-Monetary Comparison of Alternatives 12

4.1.4 Methodology for Cost Estimation 12

4.1.5 Cost Comparison of Alternatives 14

4.1.6 Benefit-cost Comparison of Alternatives 14

5.1 Recommended Alternative 15

Tables

1 Proposed General Design Criteria for Purpose of Developing Solids Management Alternatives..... 2

2 Selected Results from Ultimate & Proximate Analysis of Solids from JDWWTP and MWWTP 3

3 Summary of CBJ Biosolids Disposal Amounts in Wet Tons (WT) in Calendar Year (CY) 2013 5

4 Results of Developing and Weighting Non-Monetary Criteria Used in Alternatives Evaluation 10

5 Estimated Annual Greenhouse Gas (GHG) Emissions (Carbon Footprint) of Each Alternative 11

6 Results of Developing and Weighting Non-Monetary Criteria Used in Alternatives Evaluation 12

7 CBJ Reference Unit Costs..... 13

8 Capital Cost Breakdown of Alternatives for MWWTP Facility Location 16

9 Capital Cost Breakdown of Alternatives for JDWWTP Facility Location..... 17

10 Annual O&M Cost Breakdown of Alternatives for MWWTP Facility Location 18

11 Annual O&M Cost Breakdown of Alternatives for JDWWTP Facility Location..... 18

12 Net Present Value (NPV) Cost Estimates of the Alternatives for MWWTP Facility Location 19

13 Net Present Value (NPV) Cost Estimates of the Alternatives for JDWWTP Facility Location..... 19

14 Benefit-cost Score of Alternatives for MWWTP Location 20

15 Benefit-cost Score of Alternatives for JDWWTP Location..... 20

Figures

1	Belt Drying Process Schematic.....	7
2	Dried Biosolids Product from a Belt Dryer (courtesy of Kruger).....	7
3	BioCon Dryer and Energy Recovery System (BioCon-ERS) Process	8
4	BioCon-ERS Incinerator Furnace	8
5	Typical Fluidized Bed Incinerator (FBI) and Accessories.....	9
6	Stacked Bar Chart Display of Non-monetary Criteria Rankings of Alternatives 1-4	13
7	Net Present Value of Capital and O&M Costs for All Alternatives Relative to Status Quo Option for MWWTP Facility Location	19
8	Net Present Value of Capital and O&M Costs for All Alternatives Relative to Status Quo Option for JDWWTP Facility Location.....	20
9	Benefit-Cost Scores for All Alternatives Relative to Status Quo Option for MWWTP Facility Location.....	21
10	Benefit-Cost Scores for All Alternatives Relative to Status Quo Option for JDWWTP Facility Location.....	21

TM 3 - Long Term Plan and Operating Strategies

1.1	Introduction	1
2.1	Recommended Alternative	1
2.1.1	Results of Alternative Evaluation Workshop	1
2.1.2	Description of Recommended Alternative	4
2.1.3	Planning and Siting Recommendations	6
3.1	Recommended Operating Strategies.....	9
3.1.1	Operating Strategies at Similar Facilities	9
3.1.2	Recommended Operating Strategies for CBJ.....	11
4.1	Project Phasing and Scheduling Options	12
4.1.1	Anticipated Project Schedules under Two Delivery Options	12
4.1.2	Recommended Next Steps.....	13

Tables

1	Advantages/Disadvantages of Biosolids Facility Location	7
2	Summary of Operating Belt Drying Facilities in the USA (dryers manufactured by Kruger)	10
3	Anticipated Project Schedule under Option 1: Construction of Drying and Heat-Recovery Systems in a Single Capital Project	12
4	Anticipated Project Schedule under Option 2: Construction of Drying and Heat-Recovery Systems in a Single Capital Project using Progressive Design-Build Delivery Approach.....	13

Figures

1	Benefit-Cost Scores of Alternatives 1-4 with Biosolids Management Facility at MWWTP	2
2	Benefit-Cost Scores of Alternatives 1-4 with Biosolids Management Facility at JDWWTP	2
3	Comparison of NPW (Capital and O&M Cost Components) among Alternatives 1-4 with Biosolids Management Facility at MWWTP	3
4	Comparison of NPW (Capital and O&M Cost Components) among Alternatives 1-4 with Biosolids Management Facility at JDWWTP.....	3
5	Belt Dryer Schematic Diagram	5
6	Simplified schematic Diagram of Alternative 3 – Thermal Drying with Energy Recovery Furnace, Based on Kruger BioCon-ERS Model	6
7	Potential Location of Thermal Dryer with Energy Recovery Furnace at the JDWWTP Site.....	8
8	Potential Location of Thermal Dryer with Energy Recovery Furnace at the MWWTP Site	9
9	General Arrangement Drawing of Thermal Dryer with Energy Recovery Furnace.....	10

Biosolids Treatment and Disposal Evaluation – Phase II

Executive Summary

PREPARED FOR: City/Borough of Juneau (CBJ), Alaska

PREPARED BY: CH2M HILL

DATE: September 2, 2014

1.1 Project Goals and Objectives Accomplished

The City/Borough of Juneau's (CBJ's) Biosolids Treatment and Disposal Evaluation has built upon recent investigations by CBJ into possible disposal and treatment alternatives for the waste biosolids produced at CBJ's Juneau-Douglas Wastewater Treatment Plant (JDWWTP) and Mendenhall Wastewater Treatment Plant (MWWTP). The following objectives were completed as part of this project and are described in the three Technical Memorandums (TMs) that form the body of this report:

1. Pertinent data and information provided by CBJ related to recent and current biosolids production and disposal practices were reviewed and summarized (TM1).
2. Federal, state, and local regulations, were also reviewed and summarized, providing a regulatory outlook for CBJ's future biosolids use or disposal options (TM1).
3. Design criteria were developed for the analysis of biosolids management alternatives for CBJ, based on historical records and population projections (TM2).
4. Evaluation criteria for the alternatives evaluation were developed and weighted by the project team (TM2).
5. Potential alternatives for long-term biosolids management evaluation were screened and narrowed down to three new alternatives, in addition to the alternative of continuing current biosolids management practices, for more detailed evaluation (TM2).
6. The results of the alternatives evaluation were reviewed and discussed in a project workshop, and then one alternative was selected for implementation: a belt-driven thermal dryer with energy-recovery furnace (TM2).
7. An implementation plan with recommended operating strategies, delivery options, and schedules was developed (TM3).

1.2 Design and Evaluation Criteria

Based on a review of historical conditions and projections of future conditions for the CBJ, Table ES-1 presents design solids-loading criteria developed for biosolids management facilities at the JDWWTP and the MWWTP, (which includes the Auke Bay WWTP solids), and combined loadings from both facilities. The units describing biosolids quantity are in dry tons per day (DT/day) and wet tons per day (WT/day). The projected loadings are based on historical trends summarized in the Phase 1 report, supplemented by data from calendar year 2013. Population projections do not predict any significant growth of the CBJ's service area in the next 20 years. CBJ decided, however, to add 10% reserve capacity to current solids loading estimates to account for the potential of increased industrial activity and population growth in the future.

Belt filter presses at both WWTPs produced an average of 15.8% solids in 2013, but WWTP production records show that dewatered cake solids range from 14% to 17% solids on a day-to-day basis. For sizing of future biosolids handling facilities, it is conservatively assumed that dewatering facilities at both WWTPs will produce 15% Total Solids (TS). If the dewatering operations can produce solids of higher TS content than 15% TS in the future, then the future biosolids handling facilities will have additional reserve capacity, which will provide for more redundancy and flexibility in operations.

TABLE ES-1
Design Criteria for CBJ’s Solids Management Alternatives

Design Criterion	JDWWTP Solids	MWWTP Solids	Combined Solids	Remarks
Average Annual Solids Loading	0.8 DT/day	2.6 DT/day	3.4 DT/day	Annual average loadings are used for estimating O&M costs
Average Annual Solids Concentration	15% TS	15% TS	15% TS	It is assumed that existing solids dewatering capability can be maintained, but not improved. Even though 15.8% TS was achieved in 2013, 15% TS is assumed for conservatism in design.
Average Annual Solids Loading, WT/day	5.3 WT/day	17.3 WT/day	22.6 WT/day	This is the mathematical result of dry solids loadings divided by %solids fraction.
Maximum Month/Average Day Peaking Factor	1.5	1.3	1.35	Slightly more conservative than existing peak factors.
Maximum Month Solids Loading, DT/day	1.2 DT/day	3.4 DT/day	4.6 DT/day	Monthly maximum daily values are assumed for design with sufficient liquid storage capacity to handle daily and weekly peak loadings.
Maximum Month Solids Loading, WT/day	8.0 WT/day	22.7 WT/day	30.7 WT/day	The maximum month, average daily biosolids production rates in WT/day govern sizing of drying and incineration equipment.

Biosolids samples taken during the study indicate that levels of metals are safe and well below EPA limits. Odors and pathogen indicators typically found in untreated biosolids can be reduced by appropriate treatment. There are a number of technologies that can convert biosolids to topsoil amendments or low-grade fertilizers, but there does not appear to be sufficient market demand in Juneau to use these products, so CBJ’s primary drivers for biosolids management are volume reduction to reduce disposal costs and odor reduction to minimize impacts on the public.

The Juneau area poses some unique geographical challenges that point toward a general need for more established and reliable technologies. These challenges include a relatively remote location, limited transportation options that may result in delayed shipments for equipment, an unpredictable climate, and lack of specialized support services. Considering these factors, project team members agreed that the responsible choice for CBJ is to settle on an established or innovative technology (according to the Environmental Protection Agency’s [EPA’s] definitions for established, innovative, and embryonic technologies) that can demonstrate a successful track record of operating facilities.

The project team agreed upon the following three governing principles for selecting a biosolids management alternative:

1. Need Class A pathogen reduction to create an “exceptional quality” biosolids
2. Need to have multiple options for end use to minimize risk of disposal
3. Need to maximize volume reduction to the extent possible.

Based on these governing principals, the following three alternatives were selected for more detailed analysis:

1. Thermal dryer with production of Class A biosolids
2. Dryer with energy-recovery furnace
3. Stand-alone incinerator (fluidized bed type)

Table ES-2 shows the evaluation criteria and weightings developed by the project team for alternatives analysis. The criteria weights were assigned based on a prioritization exercise completed by the team at Workshop 1 and refined in Workshop 2. The alternatives were then scored against those criteria based on a high probability of meeting or exceeding current and future needs (high score) or low probability of meeting or exceeding current and future needs (low score).

TABLE ES-2
Non-Monetary Criteria and Weightings Used in Alternatives Evaluation

Criteria No.	Evaluation Criteria	Criteria Weights	Criteria Descriptions
1	Ease of operation	9.1	Relative ease of operating the technologies involved in each alternative, compared to existing operations. Technologies considered easier to operate receive higher score.
2	Carbon footprint	3.6	An estimate of the amount of greenhouse gas (GHG) emissions that would be emitted as a result of implementing each of the alternatives. Lower GHG emissions receive higher score.
3	Timeline for implementation	14.5	Estimated time required to implement each alternative, relative to other alternatives. Alternatives with faster timeline receive higher score.
4	Location of the technology	1.8	Flexibility to locate the facilities involved in each alternative at any one of three possible locations (JDWWTP, MWWTP, and Capitol Landfill) relative to other alternatives. Alternatives with greater location flexibility receive higher score.
5	Logistics of transport	7.3	Ease or difficulty in which end product from each alternative (dewatered cake, dried solids, or ash) can be transported, relative to other alternatives. Alternatives with end products considered easier to transport receive higher score.
6	Public health & safety issues	18.2	Possibility of each alternative to create public health or safety issues relative to the other alternatives. Greater possibility of creating issues results in lower score.
7	Environmental & permitting issues	7.3	Likelihood of each alternative to encounter environmental or permitting problems, relative to the other alternatives. Higher likelihood of problems results in lower score.
8	Risk	16.4	The amount of risk associated with implementing each alternative, from the perspectives of new technology, process complexity, and possibility of failure during operations, relative to the other alternatives. Alternatives with higher risk receive lower score.
9	End product disposal method	10.9	Likelihood of each alternative to experience ease or difficulty with end product disposal. Greater anticipated difficulty results in lower score.
10	Energy consumption & sourcing	10.9	Estimated amount of energy and source of energy required by each alternative compared with the other alternatives. Higher score to alternatives with lower energy requirements and higher scores to alternatives that can create energy or use local energy sources.
Total Weight		100.0	

1.3 Results of Alternatives Evaluation

The alternatives for biosolids management selected by the CBJ for detailed evaluation were:

1. Continuation of the current practice of shipping dewatered biosolids from the JDWWTP and the MWWTP by barge to Oregon for landfill disposal (also known as the “status quo” or “base case” alternative).
2. Thermal drying of biosolids at a central facility with local disposal or marketing of the dried, Class A biosolids product.
3. Thermal drying of biosolids followed by combustion of the biosolids in a furnace to recover heat that is then recirculated to the biosolids drying process, thus reducing the amount of purchased fuel.
4. Thermal combustion (incineration) of the biosolids in a new fluidized-bed incinerator that recovers heat from the combusted biosolids to aid in evaporation and reduce the amount of purchased fuel.

Figure ES-1 presents in bar chart format the results of the non-monetary evaluation using the criteria and weightings described above:

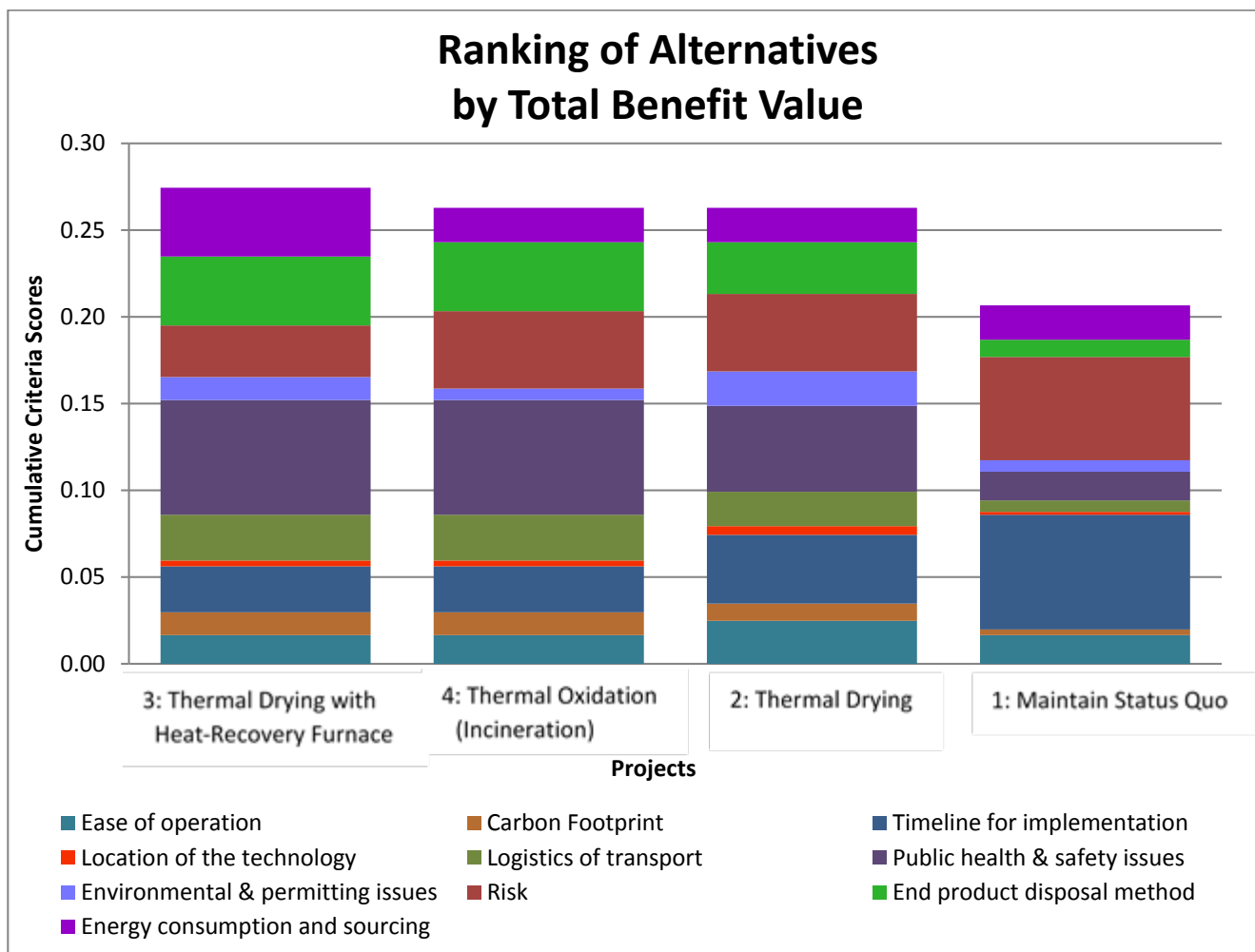

FIGURE ES-1
Stacked Bar Chart Display of Non-monetary Criteria Rankings of Alternatives 1-4

As shown in Figure ES-1, Alternative 3 (Dryer and Heat-Recovery Furnace), ranked highest in non-monetary terms. Alternative 2 (Thermal Drying) and Alternative 4 (Incineration) tied for next highest ranking. Alternative 1 (Continued Status Quo of Landfill Disposal) ranked lowest in non-monetary terms.

Cost estimates including capital costs, annual operation and maintenance (O&M) costs, and net present value, were also developed. All costs were derived using the same level of estimating accuracy so the cost estimates for the four alternatives are comparable. Actual construction costs may differ from the estimates presented, depending on specific design requirements and the economic climate at the time a project is bid. The American Association of Cost Engineers (AACE) has developed levels of accuracy for various stages of construction cost estimation. The estimates produced for the current comparison are Class 5, with a corresponding project definition level of 0-2% and expected level of accuracy of 20-50% below and 30-100% above the cost given.

The cost estimates for each alternative varied depending on whether biosolids processing is centralized at the MWWTP or JDWWTP, as summarized in Tables ES-3 and ES-4.

TABLE ES-3

Net Present Value (NPV) Cost Estimates of the Alternatives for MWWTP Facility Location

Alternative Number	Name of Alternative	NPV of Capital Cost	NPV of Annual O&M Costs	Total NPV
1	Maintain Status Quo	\$2,700,000	\$32,200,000	\$34,900,000
2	Thermal Drying	\$18,300,000	\$16,100,000	\$34,400,000
3	Thermal Drying with Heat-Recovery Furnace	\$26,600,000	\$9,400,000	\$36,000,000
4	Thermal Oxidation (Incineration)	\$50,200,000	\$10,900,000	\$61,100,000

TABLE ES-4

Net Present Value (NPV) Cost Estimates of the Alternatives for JDWWTP Facility Location

Alternative Number	Name of Alternative	NPV of Capital Cost	NPV of Annual O&M Costs	Total NPV
1	Maintain Status Quo	\$2,700,000	\$32,200,000	\$34,900,000
2	Thermal Drying	\$19,500,000	\$17,500,000	\$37,000,000
3	Thermal Drying with Heat-Recovery Furnace	\$27,900,000	\$10,700,000	\$38,600,000
4	Thermal Oxidation (Incineration)	\$51,500,000	\$12,300,000	\$63,800,000

The non-monetary criteria were then combined with the total costs to produce a Benefit-Cost score. In this evaluation, following the traditional procedure for Benefit/Cost evaluations, the total non-monetary scores were assigned a 50% weighting and the NPV scores were assigned the remaining 50% weighting in computing the Benefit/Cost scores of each alternative. As with the O&M and capital cost comparisons, each of the new alternatives is shown as having a higher or lower benefit-cost score than the Status Quo alternative, which is assigned a 100% baseline score.

Figures ES-2 and ES-3 depict the relative Benefit/Cost scores of each alternative in bar chart format.

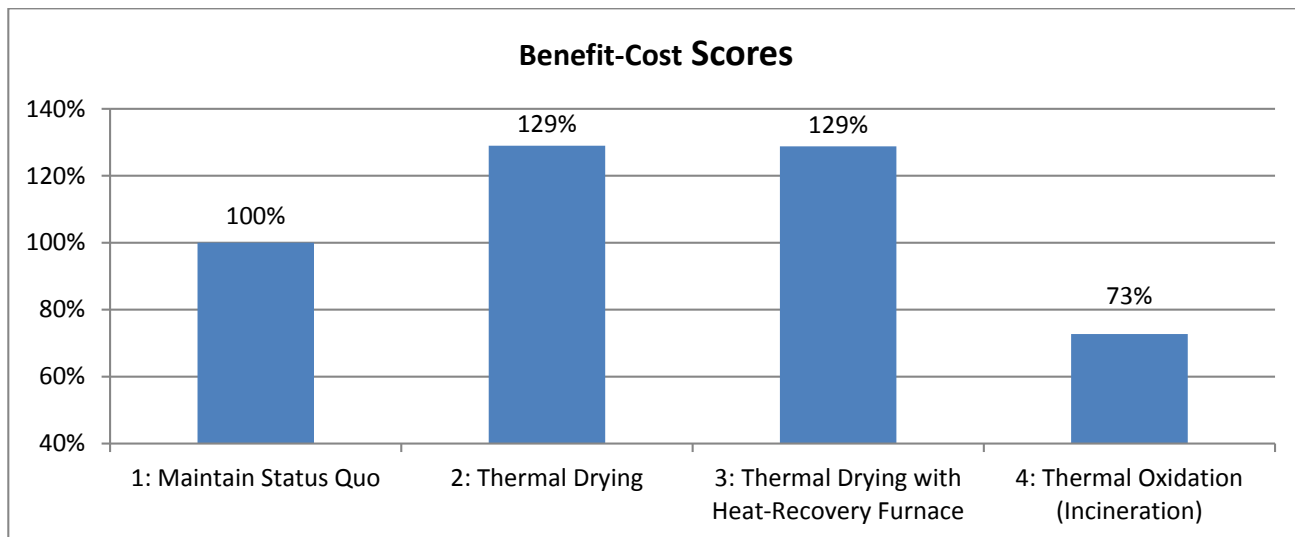

FIGURE ES-2

Benefit-Cost Scores for All Alternatives Relative to Status Quo Option for MWWTP Facility Location

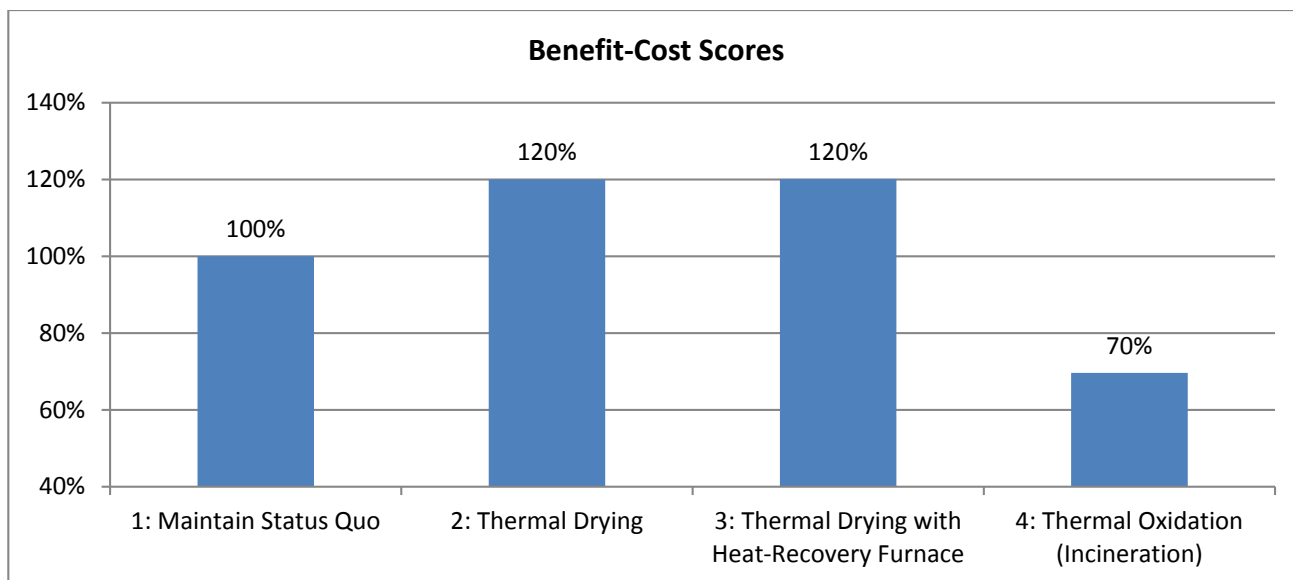

FIGURE ES-3
Benefit-Cost Scores for All Alternatives Relative to Status Quo Option for JDWWTP Facility Location

If CBJ has sufficient capital funds to pay for the slightly higher capital cost of Alternative 3, then substantial annual savings can be achieved by reduction of O&M costs associated with Alternative 3. Also, if an opportunity exists to defray the capital costs through grant funding, Alternative 3 would be the most desirable alternative to implement in monetary terms, because the investment in higher capital for Alternative 3 would substantially reduce CBJ’s annual O&M costs. Alternative 3 also scored highest in the non-monetary evaluation; therefore, **Alternative 3** – Thermal Drying with Heat-Recovery Furnace (energy recovery system) is the recommended alternative for implementation.

1.4 Recommended Operating Strategy

There are two potential site locations for CBJ’s biosolids drying facility, the MWWTP or the JDWWTP. The MWWTP produces almost 80% of CBJ’s biosolids, so would be the logical choice for siting a central biosolids management facility to reduce the extent of biosolids hauling. However, the site at MWWTP is more constrained, and the Mendenhall Valley where the MWWTP is located is currently a non-attainment area for air emissions, which would likely increase the cost of permitting and air-emissions technology at the MWWTP. The JDWWTP site has more available space and a wider buffer from its adjacent properties, and is not as sensitive as the MWWTP site with respect to its air-permitting requirements.

Based on CH2M HILL’s recent phone and email survey of other belt dryers operating in the USA, it is recommended that CBJ plan to operate its belt dryer and heat-recovery furnace around-the-clock when it has sufficient solids inventory. Both the JDWWTP and MWWTP appear to have sufficient pre-dewatering solids storage capacity, although the JDWWTP has more storage volume in its aerobic digestion basin than the MWWTP has in its settled-solids holding tank.

It does not appear that CBJ would need to have staff onsite around-the-clock to oversee operation of a drying/heat recovery facility. Similar to several other belt drying facilities in the U.S., unattended operation of the dewatering and drying systems would be possible, provided that system monitoring can be done remotely via internet or telephone. Control systems for CBJ’s thermal drying facilities would need to be designed with special features for remote operation.

Transport of dewatered biosolids will be required from one of the WWTPs to the other WWTP where the thermal drying facilities are located. It is recommended that truck hauling be done at night to decrease hauling time, and minimize the potential for traffic problems and odor complaints.

1.5 Recommended Project Delivery Method

It is recommended that the project be implemented and phased under one of the following two methods:

1. Design of belt drying system and heat-recovery furnace in a single capital project using a traditional design-bid-build approach.
2. Construction of drying and heat-recovery systems in a single capital project using progressive design-build delivery approach

Table ES-5 presents a general project schedule under the Option 1 scenario above, in which the belt drying system and heat-recovery system would be designed and installed together as part of the same capital project.

TABLE ES-5

Anticipated Project Schedule under Option 1: Construction of Drying and Heat-Recovery Systems in a Single Capital Project

Activity	Year	2014	2015				2016				2017→		
	Quarter	4 th	1 st	2 nd	3 rd	4 th	1 st	2 nd	3 rd	4 th	1 st	2 nd	3 rd
Preliminary Engineering													
Project Funding*													
Design & Permitting													
Dryer/Furnace Procurement & Submittals													
Dryer/Furnace Manufacturing & Delivery*													
Bidding and Construction**													
Startup**													
Full-scale Operations													

*The dryer/furnace manufacturing/deliver and construction schedule are tied to project funding availability.

**Construction phase ends at substantial completion; final completion would occur after successful startup.

It may be possible to accelerate the schedules shown in Table ES-5 by up to six months using an alternative delivery method such as progressive design-build or construction management at-risk. Under progressive design-build delivery, for example, the project schedule would be compressed in the design and construction phases, since those phases would be delivered by the Design-Build Contractor. An anticipated project schedule under progressive design-build delivery is shown in Table ES-6.

There are a number of challenges related to utilizing an alternative approach other than traditional design-bid-build in Alaska. Very few if any public utilities in Alaska have used alternative delivery methods on projects of significant size. Also, a Certificate to Construct is required prior to beginning construction of a water or wastewater facility in Alaska. To get the Certificate to Construct, design documents must be submitted to ADEC for plan review at the 95% completion level. Plan review times by ADEC are not predictable and with a relatively new technology, could be protracted.

Even though Table ES-6 shows the potential for saving 3-6 months on the project schedule with an alternative delivery approach, the time requirement for ADEC review of 95% design documents prior to construction may negate any potential time savings under a design-build approach.

TABLE ES-6

Anticipated Project Schedule under Option 2: Construction of Drying and Heat-Recovery Systems in a Single Capital Project using Progressive Design-Build Delivery Approach

Activity	Year	2014	2015				2016				2017→	
	Quarter	4 th	1 st	2 nd	3 rd	4 th	1 st	2 nd	3 rd	4 th	1 st	2 nd
Preliminary Engineering												
Project Funding & DB Contractor Selection*												
Design, Permitting, and Construction**												
Dryer/Furnace Procurement & Submittals												
Dryer/Furnace Manufacturing & Delivery*												
Startup**												
Full-scale Operations												

*The dryer/furnace manufacturing/deliver and construction schedule are tied to project funding availability.

**Construction phase ends at substantial completion; final completion would occur after successful startup.

Therefore, it is recommended that CBJ plan to implement the project using the more traditional, design-bid-build approach as shown in Table ES-5, which is more predictable and will reduce the possibility of unexpected delays. Preliminary engineering would need to get underway in the last quarter of 2014 and be completed in the first quarter of 2015, and project funding would need to be identified by early 2015, for the project to proceed on schedule and begin construction by early 2016, then have an operational biosolids-drying facility by late 2016 or early 2017.

Discussions and decisions regarding the project funding and delivery method would need to occur during the preliminary engineering phase, at which point one of the delivery options described above will be chosen, along with the preferred project funding mechanism, which will include exploration of alternatives to defray project capital costs through grants and low-interest loans.

Biosolids Treatment and Disposal Evaluation – Phase II Data Review & Regulatory Conditions and Outlook

PREPARED FOR: City/Borough of Juneau (CBJ), Alaska
PREPARED BY: CH2M HILL
DATE: July 8, 2014

1.1 Introduction

The purpose of this technical memorandum (TM) is two-fold:

1. To summarize CH2M HILL's review of data and information provided by City/Borough of Juneau (CBJ) regarding production and characteristics of waste activated solids, hereinafter referred to as "solids," or "biosolids."
2. To summarize federal, state, and local regulations and to provide a regulatory outlook pertinent to CBJ's future biosolids use or disposal options.

This TM updates information provided in the prior Biosolids Management System Alternatives Study, dated April 1, 2013, which was conducted for CBJ and is referred to herein as the Phase 1 Biosolids Report. Information from the Phase 1 Biosolids Report will not be repeated in this TM unless it is necessary to provide context to the updated information. When necessary for the project record, some information from the Phase 1 Biosolids Report may be corrected and updated in this TM.

2.1 Summary of Information Received to Date

Table 1 lists relevant documents and information that CBJ has provided to CH2M HILL since the project began through the date of this TM.

TABLE 1

Summary of Documents and Historical Data provided by CBJ to CH2M HILL related to Biosolids Study

Brief Description of Data or Document	Data or Document Source, Date, and Comments
Biosolids Management System Alternatives Study	By Tetra Tech, dated April 2013
2010 Biosolids Metals Analyses	Received, but not in useable format. Requested additional analyses.
Drawings by Carson Dorn for JDWWTP Incinerator Improvements	Received in PDF format, dated 2010. Some cost estimates also provided by email
Memo from Lammergeier CleanTech to CBJ about supercritical water oxidation (SWO) system	Received via email, dated May 2012
MWWTP Power Bill for Sept. 2013	Received as PDF attachment to email
CBJ Request for Bids – Biosolids Disposal Services	Nov.-Dec. 2013; project was cancelled
TM on Fats, Oils & Grease (FOGs) by Tetra Tech	Dated May 2013, received from CBJ via email
Email from Robert Deering of April 1, 2014 to CBJ about Genifuel technology	Received via email from CBJ
Dec. 2013 Letter from Ecological Engineering Group to CBJ proposing anaerobic co-digestion	Received via email from CBJ
Email from Robert Deering of April 1, 2014 to CBJ about gasification project in Covington, TN by PHG Energy	Received via email from CBJ
TM on Incorporating Aerobic Digestion with Membrane Thickening into Other Treatment and Disposal Options	By Tetra Tech dated, 11/29/13
TM on Pretreatment for Aerobic Digestion/Membrane Thickening Process at MWWTP	By Tetra Tech dated, 12/2/13
Descriptive List of Biosolids Treatment Alternatives for CBJ, including Incineration, ATAD, Composting, and Drying	By Tetra Tech, dated 9/19/13
Same List of Alternatives noted above, except in Matrix Format	By Tetra Tech, dated 9/23/13
Monthly Operating Reports for MWWTP and JDWWTP	Provided by CBJ
NPDES Permits for ABWWTP, JDWWTP, and MWWTP	From CBJ website
CBJ 2008 Comprehensive Plan and 2014 & 2015 Capital Improvement Plans	From CBJ website
Aerial Photos and Site Plans of JDWWTP and MWWTP	Provided by CBJ
Air Emissions Permit and Correspondence for JDWWTP Incinerator	Provided by CBJ
Information on Supply and Price of Wood Pellets as Heating Fuel	Emailed by CBJ, June 2-3, 2014

3.1 Review of Solids Production Data

The CBJ owns and operates the following three wastewater treatment plants (WWTPs):

1. Auke Bay WWTP (ABWWTP), a facility where waste activated solids are stored aerobically and trucked to the MWWTP (see below). The ABWWTP has a permitted treatment capacity of 0.16 million gallons per day (MGD), expressed as a maximum daily limit.
2. Mendenhall WWTP (MWWTP), located north of downtown Juneau near the mouth of the Mendenhall River. Waste activated solids from MWWTP are not digested. Solids from ABWWTP are combined with MWWTP solids at the MWWTP and dewatered by belt filter press to approximately 15% total solids (TS). The MWWTP has a permitted treatment capacity of 4.9 million gallons per day (MGD), expressed as a maximum daily flow. No monthly average flow capacity is specified.
3. Juneau-Douglas WWTP (JDWWTP), located south of downtown Juneau near the Rock Dump Industrial Area and barge lines terminal. Waste activated solids from JDWWTP are aerobically digested and dewatered by belt filter press to approximately 15% TS. The JDWWTP has a permitted capacity of 2.76 MGD expressed as a maximum-month daily average, and 6.0 MGD expressed as a maximum daily flow.

As noted above, solids are generated only from the MWWTP and the JDWWTP. In order to update the information on solids production that was provided in the Phase 1 Biosolids Report, CH2M HILL examined monthly operating reports from MDWWTP and JDWWTP for calendar year 2013. Table 2 shows the solids production rates from the MWWTP, JDWWTP, and combined solids production, for the calendar year 2013.

TABLE 2
2013 Solids Production from CBJ’s MWWTP and JDWWTP, plus Combined Totals

Solids Source: Month	MWWTP		JDWWTP		Combined Solids	
	Wet Tons	Dry Tons	Wet Tons	Dry Tons	Wet Tons	Dry Tons
Jan	526	58	0	0	526	58
Feb	518	56	180	27	697	82
Mar	425	83	217	27	642	109
Apr	485	59	126	17	611	77
May	457	76	199	33	657	109
Jun	386	66	152	26	539	92
Jul	425	58	152	27	577	85
Aug	455	75	155	27	610	102
Sep	377	75	147	26	524	101
Oct	536	68	166	25	702	92
Nov	356	86	86	13	442	99
Dec	371	82	94	16	465	99
Annual Totals:	5318	840	1675	264	6993	1105
Annual Average Day Rate (tons/day)	14.6	2.3	4.6	0.72	19.2	3.0
Maximum Month Average Day Rate (tons/day)	17.2	2.9	7.0	1.1	22.6	3.5
Maximum Month/ Average Day Peaking Factor	1.2	1.3	1.5	1.4	1.2	1.2
Annual Average %TS	15.8%		15.8%		15.8%	

The capabilities of the belt filter presses used for solids dewatering are similar at the MWWTP and JDWWTP, and each facility produced solids averaging 15.8% TS in 2013. Closer review of operating records shows dewatering performance at both WWTPs ranging from 14% to 17% TS on a daily basis.

The peaking factors of maximum month to average daily solids production are higher at the JDWWTP than at the MWWTP, but that is largely because no solids dewatering was performed at the JDWWTP in January and early February 2013, resulting in a backlog of solids that had to be dewatered in late February and March at the JDWWTP.

Solids production from both WWTPs combined shows more consistency and lower peaks than solids produced from each WWTP individually. Conversations with CBJ staff indicated that is partially due to the transport of solids from one WWTP to another on occasions of equipment outages and other operational issues.

The average daily biosolids production rates for 2013 are in line with average daily rates for 2012 as shown in the Phase 1 Biosolids Report. A combined daily average of 18.5 wet tons per day (WT/day) and 2.8 dry tons per day (DT/day) were reported for 2012, as compared with a combined daily average of 19.2 WT/day and 3.0 DT/day for 2013 as shown above.

Figure 1 depicts combined solids production from CBJ’s JDWWTP and MWWTP in 2013, shown in bar chart format as wet tons and dry tons for each month of the year.

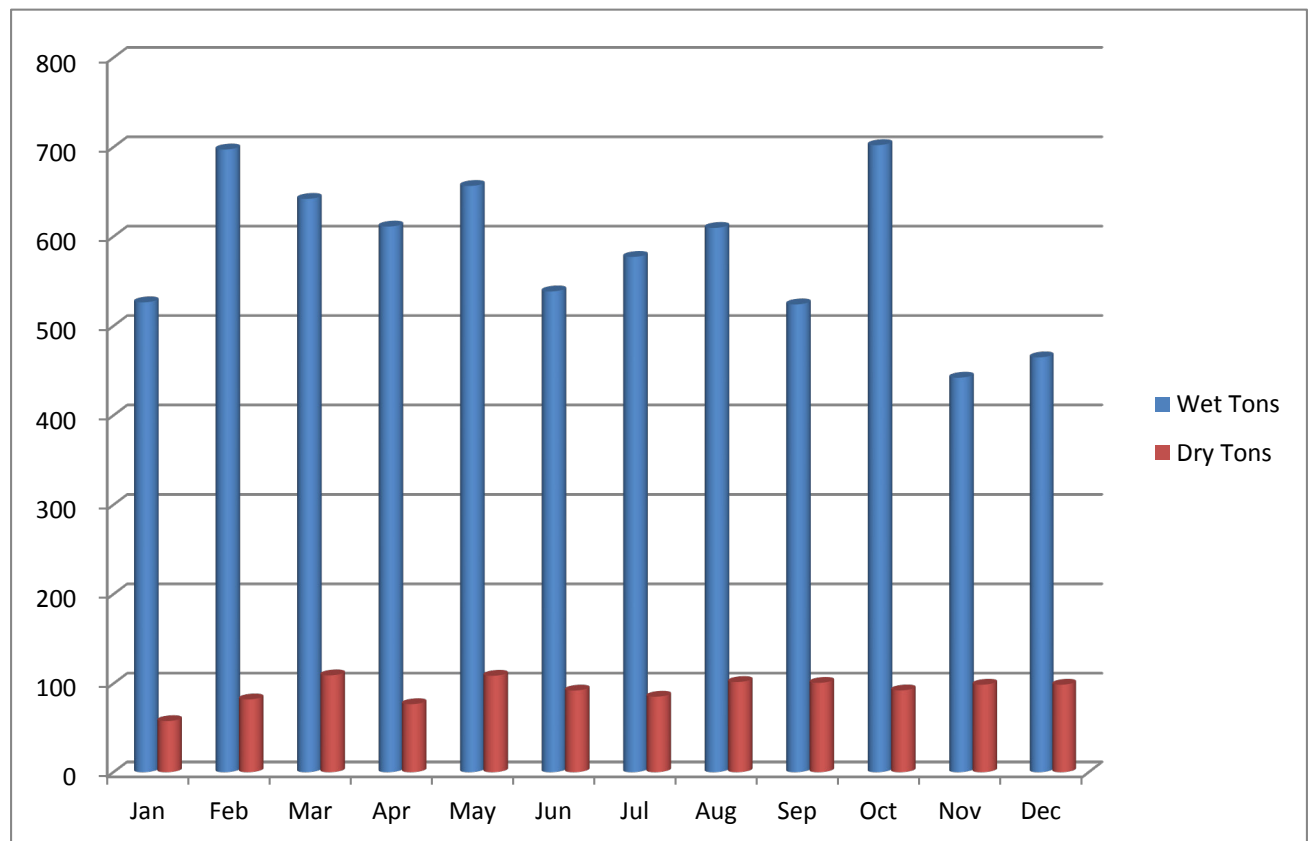

FIGURE 1
Total Monthly Solids Production from CBJ’s MWWTP and JDWWTP in 2013

Figure 1 shows that monthly solids production (similar to monthly wastewater flows) did not vary considerably over the course of the year in 2013. Based on review of the 2013 biosolids data and the Phase 1 report, it is concluded for planning purposes that a traditional peaking factor of 1.35 can be applied to the annual average to derive the maximum monthly loadings.

Altogether, 2013 was a typical year in terms of solids production rates and trends, as compared with prior data from the Phase 1 Biosolids Report and confirmed by CBJ staff, thereby establishing a baseline for solids projections.

3.2 Review of Solids Characteristics and Analytical Results

Review of the Phase 1 Biosolids Report indicates that historical laboratory analyses of biosolids were not analyzed or reported in terms useful for comparison with the EPA Part 503 Rule that governs biosolids use and disposal. Therefore, new analyses were ordered as part of the current study. The first set of results were from samples taken at the JDWWTP and MWWTP on May 14, 2014, with results reported on May 29, 2014. The results are summarized and compared with EPA Part 503 pollutant ceiling limits in Table 3.

The results shown in Table 3 indicate that the regulated pollutants in dewatered biosolids from JDWWTP and MWWTP are all safely below the limits stipulated in the EPA Part 503 Rule, typically by an order of magnitude. While these grab samples are not necessarily representative of biosolids quality throughout the year, the low levels of regulated pollutants indicate that there should not be any issues with beneficial use or disposal of CBJ’s biosolids with respect to presence of these regulated constituents.

TABLE 3
Comparison of EPA Part 503 Pollutant Ceiling Limits and “Exceptional Quality” Pollutant Concentration Limits with Results of Recent Solids Analyses from JDWWTP and MWWTP

Pollutant	EPA Part 503 Subpart B Pollutant Ceiling Concentrations (mg/kg) ¹	EPA Part 503 Subpart B Pollutant Concentrations for Exceptional Quality Biosolids (mg/kg) ^{1,2}	JDWWTP Sample Results ³	MWWTP Sample Results ³
Arsenic	75	41	6.9	4.5
Cadmium	85	39	1.7	< 1.0
Chromium	NA	NA	14	6.3
Copper	4,300	1,500	520	280
Lead	840	300	20	7.6
Mercury	57	17	1.1	<1.0
Molybdenum	75	TBD	6.6	2.2
Nickel	420	420	11	3.7
Selenium	100	36	4.9	2.9
Zinc	7,500	2,800	580	390

¹ Source: Subpart B, Part 503 Regulation. All values are on a dry weight basis. Applies to all biosolids to be land-applied.

² Applies to biosolids sold or given away in bag or other container for land application, also representing the exceptional quality or “clean sludge” limits.

³ Dewatered biosolids cake sampled on May 14, 2014, and analyses reported on May 29, 2014.
mg/kg = milligrams per kilogram; NA = not applicable (prior standards were legally challenged)

The dewatered biosolids samples that were taken from the MWWTP and JDWWTP on May 14, 2014, were analyzed for a number of other constituents in addition to the regulated pollutants shown in Table 3. Additional results related to constituents of interest for beneficial use and disposal options are shown in Table 4 with brief remarks regarding the importance of each constituent shown.

TABLE 4

Results of Other Constituents of Interest from Recent Solids Analyses from JDWWTP and MWWTP

Constituent	JDWWTP Sample Results ¹	MWWTP Sample Results ¹	Remarks
Total Solids (TS)	14%	16%	Expressed as % of total mass, the remainder being water; shows better dewatering at MWWTP than at JDWWTP
Volatile Solids (Organic Matter)	82.4%	90.0%	Expressed as % of total solids above, volatile solids are a sign of fuel value and relative biological stability. Both samples show relatively high fuel value; MWWTP solids are not digested and so have higher fuel value and lower stability
Ash Content	17.6%	10.0%	Ash is the remaining dry matter that is not volatile and consists primarily of nutrients, silica, and metals
Total Nitrogen	7.8%	8.1%	Expressed as % of total dry mass, nitrogen levels are relatively high, showing good fertilizer value
Ammonia Nitrogen, mg/kg	980	3900	Higher ammonia in cake from MWWTP indicates lower stability and that biosolids were not digested
Nitrate, mg/kg	9.0	< 1.0	Higher nitrate in cake from JDWWTP indicates that solids were aerobically digested prior to dewatering
Phosphorus (as Phosphate)	4.3%	3.6%	Relatively high in phosphorus emphasizing good fertilizer value
pH units	6.56	5.94	Both pH results are within expected ranges but slightly acidic. MWWTP is more acidic showing fermentation of the undigested solids

¹Dewatered biosolids cake sampled on May 14, 2014, and analyses reported on May 29, 2014.

As noted in Table 4, results from these two samples show characteristics reflective of national trends for biosolids that are (1) aerobically digested, in the case of JDWWTP and (2) undigested, in the case of MWWTP. The total solids (TS) concentration was noticeably higher in the MWWTP sample (16% TS) compared with the JDWWTP sample (14% TS). This may be because undigested solids are usually easier to dewater than digested solids; however, total dry solids for 2013 averaged 15.8% at both JDWWTP and MWWTP, so the differences in dewatering characteristics between solids from the two WWTPs may be inconsequential. Volatile solids (organic matter) were higher in the undigested sample from MWWTP at 90%, but also relatively high from JDWWTP at 82.4%. High volatile solids are an indicator of higher combustibility, and the laboratory results of ultimate and proximate analysis from Hazen Labs have confirmed the higher fuel value of MWWTP solids (received later and summarized in TM2). The difference in volatile solids content of biosolids from the JDWWTP and MWWTP are also reflected in the ash contents of the two WWTP solids, where the JDWWTP solids have a higher ash content than MWWTP solids because JDWWTP solids have been partially digested.

Finally, values of the primary nutrients, nitrogen and phosphorus, were relatively high in both samples, so heat-dried solids from these two WWTPs would be expected to have good fertilizer potential. In summary, both samples reflect typical values for waste-activated solids from municipal WWTPs. The differences between CBJ's two WWTPs shown in Table 4 are mostly attributable to the partially digested nature of JDWWTP solids, compared with the undigested nature of MWWTP solids.

4.1 Review of Pertinent Federal Regulations

When biosolids are prepared to be applied to the land, placed in a surface disposal site, or incinerated, the person who performs such preparation must meet the applicable requirements specified in pertinent EPA regulations, most of which are codified under 40 CFR Part 503 (Part 503 Rule). This preparer could be the

individual who generates biosolids during the treatment of domestic wastewater or the individual who derives a material from biosolids. The latter would include, for example, the individual who blends biosolids with some other material or a private contractor who receives biosolids from a treatment works and then blends the biosolids with some other material (e.g., a bulking agent).

The record keeping and reporting requirements of the Part 503 Rule specify who must develop and retain information, what information must be developed and the length of time such information must be kept. Section 405(f) of the Clean Water Act (CWA) provides that permits issued to a publicly owned treatment works (POTW) or any treatment works treating domestic sewage shall include conditions to implement the Part 503 Regulation unless such are included in permits issued under other federal or approved state programs.

However, it should be noted that the requirements in the Part 503 Rule must be met even in the **absence** of a permit, i.e., the Part 503 Rule is self-implementing. Thus, a responsible person must become aware of the Part 503 standards, comply with them, perform appropriate monitoring and record keeping and, if applicable, report information to the permitting authority even when a permit is not issued. These standards are also directly enforceable against any individual who uses or disposes of biosolids through any of the practices addressed in the final regulations. An enforcement action can be taken against an individual who does not meet those requirements, even in the absence of a permit.

4.1.1 40 CFR Part 503 Subpart B: Land Application

The land application category includes agricultural land application, forest application, land reclamation, rangeland application, and distribution and marketing of any biosolids product that will eventually be applied to land.

The land application requirements specify maximum concentrations and annual and cumulative loadings for metals; the applicability of each is dependent on the biosolids quality and use. Land application management practices are identified. Operational standards for pathogen reduction and vector attraction reduction are also required and are discussed in detail in Section 4.1.3 of this TM.

Pollutant limits in Subpart B that apply to CBJ biosolids that may be land applied or marketed as soil amendment are shown in Table 3 of this TM. As noted previously, CBJ’s biosolids fall safely under the federal pollutant ceiling concentrations, based on MWWTP and JDWWTP biosolids samples analyzed in May 2014.

The Part 503 Rule precludes land application in the following circumstances:

- Where it is likely to adversely affect a threatened or endangered species or habitat
- To land that is flooded, frozen, or snow-covered so that biosolids enter a wetland or other waters of the U.S.
- Within 10 meters of waters of the U.S.
- At a biosolids application rate greater than the agronomic rate (nitrogen based, determined by crop need) of the site, unless otherwise specified by the permitting agency for a reclamation site

4.1.1.1 Pathogen and Vector Attraction Reduction for Land Application

Biosolids that meet the Class A pathogen requirements and meet the EQ pollutant limits are referred to as “Exceptional Quality.” As such, these biosolids have minimal regulatory requirements. Biosolids that are Class B with respect to pathogen requirements are restricted to bulk application to agricultural land, forest, or reclamation sites. Additional site restrictions, such as food crop, grazing, and public access restrictions, are specific to Class B biosolids. For Class B biosolids, one of the first 10 criteria specified under Subpart D (described in Section 4.1.3) for vector attraction reduction must be met in order to land-apply biosolids.

4.1.1.2 Potential Impacts to CBJ for Land Application of Biosolids

Based on analysis of recent samples, CBJ's biosolids are able to meet the specified Part 503 Regulation numerical limits for land application (Subpart B Tables 1-4). The critical limiting criteria will most likely be the pathogen and vector attraction reduction requirements, depending on the end-use of the biosolids. Major issues for every applier of biosolids are individual state and local requirements. State of Alaska requirements are discussed in Section 5.1.

4.1.2 40 CFR Part 503 Subpart C: Surface Disposal

Generally, surface disposal refers to sludge-only landfills (monofills) and dedicated land disposal practices. Subpart C of the Part 503 Rule applies to any person who prepares biosolids that are placed on a surface disposal site, to the owner/operator of the site, and to the surface disposal site itself. This subpart does not apply to biosolids stored on an area of land or to the land on which the material is stored. Storage, by regulatory definition, is for biosolids that remain on-site for less than 2 years. If biosolids are in the same location for more than two years, it is considered surface disposal whether or not ultimate disposal is the intent. Should the CBJ desire to site and permit a sludge-only landfill, or monofill, the Part 503 Regulation would apply, in addition to State of Alaska siting, permitting, and monitoring requirements.

The Part 503 Rule does not apply to the co-disposal of biosolids with other municipal solid waste in municipal solid waste landfills. Co-disposal or use of biosolids at municipal solid waste landfills is regulated under 40 CFR Part 258. Biosolids disposed in a municipal solid waste landfill must be non-hazardous and pass the Paint Filter Test. Other site-specific requirements may apply depending on the landfill accepting the material.

4.1.2.1 Pollutant Limits for Surface Disposal

Pollutant limits are specified for surface disposal sites without a liner and leachate collection system for three metals: arsenic, 73 mg/kg; chromium, 600 mg/kg; and nickel, 420 mg/kg. The CBJ's biosolids are safely under these metal limits based on the data reviewed. If the pollutant concentrations exceed the specified limits, and the site does not have a liner or leachate collection system, site-specific pollutants may be requested at the time of permit application. The permitting authority must determine if site-specific pollutant limits are appropriate.

4.1.2.2 Management Practices for Surface Disposal

The following requirements apply to surface disposal of biosolids:

- A surface disposal site must not adversely affect a threatened or endangered species or its habitat, and it must not restrict the flow of a base flood.
- A surface disposal site must be designed to withstand certain seismic zone conditions.
- Runoff and leachate (for systems with a leachate collection system) must be collected and disposed of in accordance with the site permit.
- Methane gas must be controlled and monitored if the unit is covered.
- Food, feed, and fiber crops must not be grown and animals must not graze on active sites unless it is demonstrated that public health and the environment are protected. Public access to site must be restricted until 3 years after closure.
- A groundwater-monitoring program must be developed to demonstrate that biosolids do not contaminate any aquifer.
- Nitrogen in the groundwater must be monitored.

4.1.2.3 Pathogen and Vector Attraction Reduction for Surface Disposal

Class A or Class B pathogen reduction requirements must be met for biosolids disposed in a surface disposal unit unless a daily soil cover is placed. If daily cover is not used, the biosolids must be Class A or Class B, and must meet one of the alternative vector attraction reduction criteria specified in Subpart D of the Part 503 Rule.

4.1.2.4 Potential Impacts to CBJ for Surface Disposal

Biosolids generators who plan to use surface disposal sites must ensure that the biosolids meet the pollutant concentration limits imposed for that site. Some monofills receive raw solids that will not meet the Class A or B requirements. If a daily cover is placed, pathogen requirements do not have to be satisfied. The CBJ’s biosolids meet the specified pollutant limits, but do not meet all pathogen and vector reduction criteria. Therefore, daily cover for the surface disposal site would be recommended for any surface disposal site, to minimize any pathogen and vector attraction concerns.

4.1.3 40 CFR Part 503 Subpart D: Pathogen and Vector Attraction Reduction

The Part 503 Rule states separate requirements for pathogen and vector attraction reduction. Pathogen requirements have two classifications: Class A and Class B, with Class A being the more stringent. Current processes to further reduce pathogens (PFRP) and processes to significantly reduce pathogens (PSRP) technologies are recognized, but pathogen density criteria must be met in addition to the use of a specific process.

Biosolids that meet the Class A pathogen requirements, one of the vector attraction reduction requirements (criteria 1 through 8 in Subpart D), and the numerical criteria (pollutant concentration limits) in Table 3, are referred to as “Exceptional Quality.” As such, these biosolids have minimal regulatory requirements.

Prior to the promulgation of the Part 503 Rule, the EPA used a technology-based approach to pathogen and vector attraction reduction by requiring that biosolids undergo either PSRP or PFRP prior to being land-applied. Although these processes are still recognized as acceptable, additional requirements are specified to ensure process reliability.

As specified in Subpart D of the Part 503 Rule, either Class A or Class B pathogen reduction requirements must be met when biosolids are applied to the land or placed on a surface disposal site. In addition, the regulations require reduction of vector attraction, that is, control of those characteristics of biosolids that attract disease-spreading agents (e.g., flies or rats) when applied to the land or placed on a surface disposal site. There are no pathogen or vector attraction reduction requirements for biosolids fired in an incinerator. Subpart B of the regulations prescribes operational standards that designate the level of pathogen reduction for certain management methods, as shown in Table 5.

TABLE 5
Pathogen Reduction Requirements from 40 CFR Part 503 Rule

Management Method	Requirement
Land Application (any)	Class A or B
Surface Disposal	Class A or B
Lawn or Home Garden	Class A
Sold or Given Away in a Bag or Other Container	Class A

4.1.3.1 Class A Pathogen Reduction Options

All options require pathogen reduction to show that the biosolids have met either a fecal coliform or *Salmonella* bacteria requirement and one of six alternatives:

- Demonstrate <1000 most probable number (MPN) fecal coliforms per gram total solids, or <3 MPN *Salmonella* per 4 grams of total solids
- Apply one of six alternatives:
 - Alternative 1 – Time and Temperature
 - Alternative 2 – Raise pH
 - Alternative 3 – Reduce enteric viruses and helminth ova (low pathogen biosolids)
 - Alternative 4 – Reduce enteric viruses and helminth ova (normal biosolids)
 - Alternative 5 – PFRP treatment
 - Alternative 6 – PFRP equivalent treatment

4.1.3.2 Class B Pathogen Reduction Options

The three options for Class B pathogen reduction are:

1. Demonstrate 2 million MPN or coliform forming units (CFUs) fecal coliforms per gram total solids
2. Apply PSRP treatment
3. Apply PSRP equivalent treatment

In addition, there are a number of site restrictions for land application for Class B biosolids.

4.1.3.3 Vector Attraction Reduction

Twelve criteria are specified in the Part 503 Rule for vector attraction reduction. The application of vector attraction reduction criteria depends on the type of biosolids and how they are to be used. For example, for biosolids that are to be land-applied, biosolids must meet at least one of Criteria 1 through 10. For surface disposal, any one of Criteria 1 through 11 may be used. Criterion 12 applies only to septage.

- **Criterion 1.** Volatile solids must be reduced by a minimum of 38 percent.
- **Criterion 2.** For anaerobically digested biosolids that cannot meet Criterion 1, bench-scale testing for 40 additional days at 30 to 37°C with 17 percent volatile solids reduction can be used.
- **Criterion 3.** Similar to Criterion 2 except that digestion takes place over 30 days at 20°C to show a 15 percent reduction.
- **Criterion 4.** The specific oxygen uptake rate (SOUR) for biosolids treated in an aerobic process shall be equal to or less than 1.5 mg O₂ per hour per gram of total dry solids.
- **Criterion 5.** For aerobic processes (e.g., composting), a minimum retention time of 14 days at 40°C must be provided. An average temperature of 45°C must be maintained.
- **Criterion 6.** Sufficient alkali must be added to raise the pH to 12 or higher for a period of 2 hours, with the biosolids remaining at a pH of 11.5 for an additional 22 hours without the use of additional alkali.
- **Criterion 7.** The total solids concentration of the portion of biosolids that does not contain unstabilized primary solids should be a minimum of 75 percent prior to blending with other materials.
- **Criterion 8.** The total solids concentration of the portion of biosolids that does contain unstabilized primary solids should be a minimum of 90 percent prior to blending with other materials.
- **Criterion 9.** Biosolids that are subsurface-injected must have no significant amount of biosolids on the surface within 1 hour after injection.
- **Criterion 10.** Surface-applied biosolids must be incorporated within 6 hours after application.

- **Criterion 11.** Biosolids placed on an active surface disposal site must be covered each operating day with soil or other material.
- **Criterion 12.** The pH of domestic septage must be raised to pH 12 by sufficient alkali addition for at least 30 minutes.

4.1.3.4 Potential Impacts to CBJ related to Pathogen and Vector Attraction Reduction

When evaluating future biosolids management options, the CBJ should consider the following pros and cons associated with producing Class A versus Class B material:

- More alternatives are available for beneficial uses of Class A products.
- Regulatory monitoring and record keeping requirements are less stringent for Class A products than for Class B materials.
- Typically, Class A stabilization requires higher O&M costs and more operator attention, which typically increases overall processing costs.
- Producing Class A products may alleviate growing public perceptions and concerns about health effects associated with pathogens.
- Consider the benefits from sale of Class A products such as heat-dried solids or compost.

4.1.4 40 CFR Part 503 Subpart E: Incineration

Subpart E of the Part 503 Regulation covers incineration. In particular, the following are specified: pollutant limits; operational standards; and frequency of monitoring, record keeping, and reporting.

Incineration is an acceptable biosolids management alternative in areas of the country where the regulatory and political climates are favorable, and few, if any, other biosolids management alternatives exist.

The construction of a new Sewage Sludge Incineration Unit (SSI) will require a Title V air permit under the Clean Air Act. The facility must apply for a Title V operating permit within 12 months of starting the sewage sludge incinerator. Title V requires a public hearing process. If it can pass the public hearing process and other application requirements, an incinerator could be built at either JDWWTP or MWWTP. The operating permit can be limited to the incinerator and the requirements in the permit should be the same as the requirements in the minor source operating permit, should a minor source operating permit be required. If no minor source operating permit is required, then the requirements of the Title V will be limited to the emission limits for the sewage sludge incinerator and general requirements for reporting, record keeping and annual fees based on the emissions from the incinerator. The Title V permit is not intended to add new requirements for the facility, but to summarize requirements all in one place. The Title V permit and minor source permit (if required) will be issued by the ADEC. State requirements are discussed in section 5.1 of this TM.

4.2 Predicted Changes to Federal Part 503 Regulation and their Potential Impacts

In the last few years, public concerns have arisen regarding beneficial uses of biosolids mostly related to Class B land application. These concerns have primarily centered on odors, aerosols, pathogens, and perceived human-health impacts. In response to these concerns, the National Research Council (NRC) of the National Academy of Sciences completed a study on the practice of biosolids land application and published a report in a report entitled *Biosolids Applied to Land: Advancing Standards and Practices (2003)*.

The EPA summarized its review of the NRC report and resulting summit session in a Federal Register notice including the following summary highlights:

- EPA will continue its biennial review of the biosolids standards and regulations as required by the Clean Water Act. This means that information from biosolids research will be collected and analyzed every two years to assess the need for regulation based on new research findings.
- EPA will continue to provide compliance assistance to the states and take enforcement actions as appropriate.
- EPA will seek improved analytical methods for identifying and measuring pathogen levels in Class A and Class B biosolids.
- EPA will conduct field studies and chemical pollutant surveys in efforts to assess the ecological and human health impacts of biosolids land application.
- EPA will be involved in microbial risk assessment, exposure measurements, and stakeholder communications in efforts to respond to public concerns with accurate scientific information.
- EPA will continue to assess the potential risks and impacts of additional contaminants as required by the Clean Water Act. Pollutants that have recently been screened for risk assessment and potential regulatory action include acetone, barium, beryllium, carbon disulfide, diazinon, manganese, butanone, nitrate, nitrite, phenol, pyrene, and silver.

It is likely that some additional regulations will be imposed on biosolids quality and monitoring requirements in the future. It is advisable for the CBJ to track these regulatory impacts and summarize them periodically.

5.1 Review of Pertinent State and Local Regulations

5.1.1 State Disposal Regulations

The ADEC is responsible for monitoring and enforcing compliance with the federal biosolids disposal standards and the state solid waste regulations, found in the Alaska Administrative Code (AAC), title 18, Chapter 60. The ADEC will review disposal systems and landfills and monofills to look for potential compliance issues with both existing and proposed rules and standards. Changes and amendments are made to these solid waste regulations from time to time and the City should make sure it is always working from the most recent set of regulations.

18 AAC 60, as amended April 12, 2013, has the following articles, which affect the final disposal or reuse of biosolids:

Article 3. Municipal Solid Waste Landfills

OR

Article 4. Monofills

Article 5. Land Application of Biosolids

5.1.1.1 Untreated Sewage Solids

Disposal of untreated sewage solids may be disposed of in a monofill and would be regulated under 18 AAC 60.470, Monofills - Sewage Solids. If the monofill is located within the boundaries of an existing municipal landfill, it is considered co-disposal of sewage solids with municipal solid waste and would be regulated under 18 AAC 60.365, Co-disposal of Sewage Solids. Any other regulations pertaining to landfill disposal practices, design standards, water quality monitoring, and liquids restrictions would apply, as discussed in Section 4.1.2.

5.1.1.2 Monofills

By definition in 18 AAC 60, a monofill is a landfill or drilling waste disposal facility that receives primarily one type of solid waste and that is not an inactive reserve pit. Monofill disposal of Class A biosolids would likely still be considered sewage solids to ADEC. Achieving Class A or Class B status would satisfy the vector reduction requirements of the regulation. Monofills may be lined or unlined, provided that they contain less than certain levels of metal contaminant concentrations and that they are not placed near a fault, in an unstable area, or in a wetland. Ongoing groundwater monitoring and post-closure care of the monofill will likely be required. Regulations require a letter from the U.S. Fish and Wildlife Service stating that the monofill is not likely to adversely affect a threatened or endangered species listed under 16 U.S.C. 1533 (Endangered Species Act, Section 4) or its designated critical habitat.

5.1.1.3 Land Application of Biosolids

The federal regulations governing land application of solids established in 40 CFR 503 and discussed in section 4.1.1 are adopted by reference by ADEC. Note that disposal of biosolids in a permitted monofill would preclude their disposal under the category of land application. An ADEC approved permit is required for any land application of treated biosolids that are not Class A. The monitoring constituents or parameters will then be selected on a site-specific basis. The requirements of 18 AAC 60.500 - 18 AAC 60.510 do not apply to the process used to treat domestic sewage or biosolids *before* their final use or disposal nor the ash generated during the firing of sewage solids.

5.1.2 End Uses

5.1.2.1 Landfill Cover

A Class I landfill such as the Juneau Capital Landfill must cover solid waste with six inches of earthen material at the end of each operating day. ADEC may approve an alternate cover material if the owner is able to demonstrate that it will control disease vectors, wildlife attraction, fire, odor, blowing litter, and scavenging, without posing a threat to public health or the environment. A Class A biosolids material by itself or blended with soil could satisfy this regulatory requirement. Workability of the biosolids material may be questionable for daily cover in high traffic areas. A Class A biosolids material may be more suited for final or interim landfill cover in low traffic areas.

5.1.2.2 Mine Reclamation and Forestry Land Application

Biosolids can and have been used nationally as a soil amendment for mine reclamation sites. The nutrient concentration of both the existing soil and the biosolids must be understood to produce a good mix for revegetation. While, the Alaska Department of Natural Resources (ADNR) and ADEC regulate mine reclamation and closure following under the State of Alaska Reclamation Act, there are no additional regulations that would preclude the use of biosolids as a soil amendment. Forestry land is likewise overseen by ADNR to monitor and ensure the integrity of the land.

Biosolids used as a soil amendment could be considered a resource for either mines or forest land. Land application in this manner would be subject to the same Solid Waste Management Regulations listed above: 18 AAC 60, Article 5, as well as 40 CFR 503, adopted by reference.

5.1.3 State Air Regulations

The state air regulations are contained in 18 AAC 50, Air Quality Control. Air regulations encompass overall ambient air quality and limit emissions from specific sources. When permitting a new source such as an incinerator, CBJ must include all air pollutant sources on the site, cumulatively. In addition to the Title V air permit required for any sludge incineration facility, state regulations may also require a construction permit. Both permits will likely apply the standard operating permit conditions of 18 AAC 50.346.

Incinerators are specifically regulated in 18 AAC 50.050 – Incinerator Emission Standards. Emissions are limited both by concentration and by weight per unit time. Incinerators have a particulate matter (PM) limit of 0.65 grams per kilogram of dry sludge input.

It is also possible that a Minor Permit may be required under 18 AAC 50.502. As a new source, the expected emissions should be checked against the limits listed in Table 6. If emissions are below these thresholds, no construction permit will be required.

TABLE 6
Minor Air Permit Limits

Pollutant	Limit	Unit
PM-10	15	tons per year
Nitrogen Oxides	40	tons per year
Sulfur Dioxide	40	tons per year
Lead	0.6	tons per year
PM-2.5	10	tons per year

Source: 15 AAC 50.502 (c) (1)

Any emissions from a CBJ WWTP will be added cumulatively to an existing inventory of pollutant sources in the area. It is not expected that limits more rigorous than those listed in Table 6 or the EPA's health-based standard will be imposed upon individual sources. The ambient air quality standards must be met in all locations in the country at all times regardless of specific emissions in the area.

It may be noted that the Mendenhall Valley area of Juneau has been designated by the EPA as "nonattainment" for PM-10, meaning that the air quality does not meet the ambient standard for small particulate matter with a diameter of 10 micrometers or less. However, through the implementation of a wood smoke control program and paving of unpaved roads, the PM-10 levels measured in the Mendenhall Valley have been about a third of the 24-hour standard since the year 2000. The ADEC is currently in the process of downgrading Juneau's PM-10 status to maintenance. The PM-10 nonattainment issues are not a factor in the ability to obtain a Title V operating permit. At this point, it appears the emissions from the existing facility and the proposed biosolids alternatives would be low enough to meet the Table 6 limits.

5.1.4 Local Requirements:

The Municipal Code of the City and Borough of Juneau contains codified requirements which should be reviewed prior to design. Chapter 36.40 – Solid Fuel-Fired Burning Devices was adopted to address airborne pollutants in the area. In the Mendenhall Valley, an air emergency will be announced when air particulate levels reach unhealthy levels. During air emergencies, all woodstove burning is prohibited; pellet stoves are exempt from the wood stove regulations and can burn at any time. This section of the Municipal Code is also adopted by reference in 18 AAC 50.030 and is thus enforceable at the State level.

Performance standards applying to industrial activity are outlined in Chapter 50 – Commercial and Industrial Standards. The selected design shall not permit the emission of obnoxious odors or toxic or corrosive fumes or gases. Dust or vapor shall not be exhausted directly into the atmosphere.

6.1 Suggested Design Criteria for Biosolids Handling Facility

This subsection will briefly propose some general design criteria in terms of projected solids loadings and general characteristics, so that the alternatives analyses can proceed without delay. Some adjustments and refinements to these general design criteria may occur as the alternative analysis develops and we obtain more information.

6.1.1 Proposed Solids Projections

Our review of area population projections and comprehensive plans indicates that the population and economic activity of the CBJ service area will remain fairly stable for an indefinite period. In other words, no significant increases or decreases in population and economic activity are expected over the 20-year planning cycle of this study. Therefore, no significant changes in biosolids production rates from the MWWTP and JDWWTP are expected over the next 20 years.

In view of the uncertainties in making 20-year projections, CBJ staff suggested in our May 8-9 project workshop that it would be prudent to add a 10% contingency to current solids loadings for developing design-year projections. Table 7 shows the proposed, general design criteria that we will issue to equipment and system vendors during the upcoming, alternatives analysis phase of the project.

TABLE 7

Proposed General Design Criteria for Purpose of Developing Solids Management Alternatives

Design Criterion	JDWWTP Solids	MWWTP Solids	Combined Solids	Remarks
Average Annual Solids Loading	0.8 DT/day	2.6 DT/day	3.4 DT/day	Annual average loadings are used for estimating O&M costs
Average Annual Solids Concentration	15% TS	15% TS	15% TS	It is assumed that existing solids dewatering capability can be maintained, but not improved. Even though 15.8% TS was achieved in 2013, 15% TS is assumed for conservatism in design.
Average Annual Solids Loading, WT/day	5.3 WT/day	17.3 WT/day	22.6 WT/day	This is the mathematical result of dry solids loadings divided by %solids fraction.
Maximum Month/Average Day Peaking Factor	1.5	1.3	1.35	Slightly more conservative than existing peak factors.
Maximum Month Solids Loading, DT/day	1.2 DT/day	3.4 DT/day	4.6 DT/day	Monthly maximum daily values are assumed for design with sufficient liquid storage capacity to handle daily and weekly peak loadings.
Maximum Month Solids Loading, WT/day	8.0 WT/day	22.7 WT/day	30.7 WT/day	The maximum month, average daily biosolids production rates in WT/day govern sizing of drying and incineration equipment.

Other design criteria may be developed as the alternatives analysis proceeds.

7.1 Summary and Conclusions

The present work by CH2M HILL is intended to build upon investigations already completed by CBJ and Tetra Tech, Inc. into possible disposal and treatment alternatives. This TM has summarized CH2M HILL's review of data and information provided by CBJ in order to provide sufficient background to begin the current project. This TM has also summarized the federal, state, and local regulations, providing a regulatory outlook for CBJ's future biosolids use or disposal options. The information received and data reviewed have been used to develop design criteria for the upcoming analysis of biosolids management alternatives for CBJ, the ultimate goal of which is a recommendation for a long-term biosolids management approach that is most appropriate and sustainable for Juneau.

At the first project workshop held on May 7-8, 2014, CBJ and CH2M HILL team members reviewed the history of the project and current issues and challenges that CBJ is facing. These include sludge constituents, sampling issues, odors, landfill acceptance, lack of available land for development, and possible lack of market for beneficial use of an end product. If CBJ sludge has a high metal content, objectionable odors, or high levels of pathogen indicators, it will affect treatment and disposal methods.

Biosolids samples taken during this study and summarized herein indicate that levels of metals are safe and well below EPA limits. Odors and pathogen levels can be reduced by appropriate treatment. While there are a number of technologies that can convert biosolids to soil amendments or low-grade fertilizers, any investigation must include a determination of whether there would be sufficient market demand in Juneau to use these products locally.

At the first project workshop, CBJ and CH2M HILL team members also discussed allowable risk tolerance. The following US EPA definitions of emerging technologies for biosolids management were used:

- **Established** – Technologies widely used (i.e. generally more than 10 facilities throughout the world) are considered well established.
- **Innovative** – Technologies meeting one of the following qualifications: (1) have been tested at a full-scale demonstration site in this country; (2) have been available and implemented in the United States (U.S.) for less than 5 years; (3) have some degree of initial use (i.e. implemented in less than ten utilities in the U.S.); and (4) are established technologies overseas with some degree of initial use in the U.S.
- **Embryonic** – Technologies in the development stage and/or tested at laboratory or bench scale. New technologies that have reached the demonstration stage overseas, but cannot yet be considered to be established there, are also considered to be embryonic with respect to North American applications.

Subsequent to the May workshop, CBJ received information on Wright Tech Systems' Biodryer™ technology. The "biodryer" is an in vessel composting system. As a composting system, the "biodryer" requires adding a biomass, like woodchips, as a bulking agent. The technology was evaluated using the governing principals established in first workshop. The CBJ eliminated composting as an acceptable technology due to insufficient available land for a facility and the unknowns surrounding both the availability of wood chips for amendment a local market for a compost product. Additionally, the biodryer technology has limited experience with biosolids. Most of the applications have been small institutional installations using food wastes as the compostable material. Any biodryer installations using biosolids are small in comparison to Juneau's biosolids production.

The Juneau area also poses some unique geographical challenges that point toward a need for more established and reliable technologies. These challenges include a relatively remote location, limited transportation options that may result in delayed shipments for equipment, an unpredictable climate, and lack of specialized support services. Considering these factors, CBJ and CH2M HILL team members agreed that the responsible choice for CBJ is to settle on an established or innovative technology that can demonstrate a successful track record of operating facilities.

The following three governing principles for selecting a biosolids management alternative were decided upon at the first workshop:

1. Need Class A pathogen reduction to create an “exceptional quality” biosolids if desired
2. Need to have multiple options for end use to minimize risk of disposal
3. Need to maximize volume reduction to the extent possible.

Based on these governing principals, the following three alternatives were selected for more detailed analysis:

1. Thermal dryer with production of Class A biosolids
2. Dryer with energy-recovery furnace
3. Stand-alone incinerator (fluidized bed type)

Evaluation criteria for the alternatives analysis were also established and weighted during the first project workshop, as shown in Figure 2.

		Ease of Operation	Carbon Footprint	Timeline for implementation	Location of the technology	Logistics of transport	Public health & safety issues	Environmental & permitting issues	Risk	End product disposal method	Energy consumption & sourcing	Score	Weight
		A	B	C	D	E	F	G	H	I	J		
Ease of operation	A	A	A	C	A	E	F	A	H	I	A	5	0.09
Relative Carbon Footprint	B		B	C	B	E	F	G	H	I	J	2	0.04
Timeline for implementation	C			C	C	C	F	C	H	C	C	8	0.15
Location of the technology	D				D	E	F	G	H	I	J	1	0.02
Logistics of transport	E					E	F	G	H	I	J	4	0.07
Public health & safety issues	F						F	F	F	F	F	10	0.18
Environmental & permitting issues	G							G	H	I	J	4	0.07
Risk	H								H	H	H	9	0.16
End product disposal method	I									I	J	6	0.11
Energy consumption & sourcing	J										J	6	0.11
												Sum of Weights	1.00

FIGURE 2
Evaluation Criteria and Weightings to be Used in Biosolids Alternatives Analysis

7.2 Path Forward

The next task is to proceed with the alternatives analysis under the design and evaluation criteria established to date. The results of the alternative evaluation will be summarized in TM2, which will be delivered to CBJ in early July, prior to Project Workshop 2, which will be held in Juneau on July 8-9, 2014.

Biosolids Treatment and Disposal Evaluation–Phase II Alternatives Evaluation and Results

PREPARED FOR: City/Borough of Juneau (CBJ), Alaska
PREPARED BY: CH2M HILL
DATE: August 7, 2014

1.1 Introduction

Objectives of this Technical Memorandum 2 (TM2) are as follows:

1. To summarize solids projections, characteristics, and conditions that comprise the design criteria for long-term biosolids management options described herein
2. To present the results of the long-term solids management evaluation, including detailed descriptions of the alternatives, the methodology used to evaluate alternatives, and evaluation results
3. To recommend an alternative for implementation, based on the results of the alternative evaluation and discussion in Workshop 2.

This TM will also cover additional information obtained since Workshop 1 on biosolids characteristics and results of additional testing not received in time for TM1. It will summarize the methodology and results of the alternatives evaluation, and present additional issues to consider in selecting and implementing an alternative. Finally, a recommendation will be made for the selected alternative.

2.1 Solids Loading Projections, Characteristics, and Design Conditions

Based on a review of historical conditions and projections of future conditions for the CBJ, Table 1 presents design solids-loading criteria developed for biosolids management facilities at the Juneau-Douglas WWTP (JDWWTP), the Mendenhall WWTP (MWWTP, which includes the Auke Bay WWTP solids), and combined loadings from both facilities. The units describing biosolids quantity are in dry tons per day (DT/day) and wet tons per day (WT/day). The projected loadings are based on historical trends summarized in the Phase 1 report, supplemented by data from calendar year 2013, with the addition of 10% reserve capacity to account for the potential of increased industrial activity and population growth in the future.

Belt filter presses at both WWTPs produced an average of 15.8% solids in 2013, but WWTP production records show that dewatered cake solids range from 14% to 17% solids on a day-to-day basis. For sizing of future biosolids handling facilities, it is conservatively assumed that dewatering facilities at both WWTPs will produce 15% Total Solids (TS). If the dewatering operations can produce solids of higher TS content than 15% TS in the future, then the future biosolids handling facilities will have additional reserve capacity, which will provide for more redundancy and flexibility in operations.

**TABLE 1
Proposed General Design Criteria for Purpose of Developing Solids Management Alternatives**

Design Criterion	JDWWTP Solids	MWWTP Solids	Combined Solids	Remarks
Average Annual Solids Loading	0.8 DT/day	2.6 DT/day	3.4 DT/day	Annual average loadings are used for estimating O&M costs
Average Annual Solids Concentration	15% TS	15% TS	15% TS	It is assumed that existing solids dewatering capability can be maintained, but not improved. Even though 15.8% TS was achieved in 2013, 15% TS is assumed for conservatism in design.
Average Annual Solids Loading, WT/day	5.3 WT/day	17.3 WT/day	22.6 WT/day	This is the mathematical result of dry solids loadings divided by %solids fraction.
Maximum Month/Average Day Peaking Factor	1.5	1.3	1.35	Slightly more conservative than existing peak factors.
Maximum Month Solids Loading, DT/day	1.2 DT/day	3.4 DT/day	4.6 DT/day	Monthly maximum daily values are assumed for design with sufficient liquid storage capacity to handle daily and weekly peak loadings.
Maximum Month Solids Loading, WT/day	8.0 WT/day	22.7 WT/day	30.7 WT/day	The maximum month, average daily biosolids production rates in WT/day govern sizing of drying and incineration equipment.

Biosolids characteristics were derived from dewatered cake samples taken in May 2014. The first set of sample results were presented in TM1. They indicate that CBJ’s biosolids are typical of undigested waste activated solids (WAS) in the case of MWWTP, showing 90% volatile solids (VS) content. In the case of the Juneau-Douglas WWTP (JDWWTP), the lower VS content of 82% VS indicates that WAS from the JDWWTP is partially digested. Other aspects of biosolids from the two WWTPs are typical of biosolids from other WWTPs.

Additional analytical results were received on June 20, 2014, from Hazen Laboratories in Denver, CO, which summarize the potential fuel value of biosolids samples from MWWTP and JDWWTP based on ultimate and proximate analyses of biosolids combustibility and energy potential. Those analytical results are summarized in Table 2.

The sample results shown above are consistent with the laboratory results of other standard parameters reported in TM1. The results show that MWWTP solids have higher fuel value than JDWWTP solids, primarily because the MWWTP solids are not digested, while JDWWTP solids are partially digested. If a central facility is built for incinerating the solids from both WWTPs, it would not be necessary to continue aerobically digesting the JDWWTP solids. Not digesting the solids at JDWWTP could save energy, increase the dewatering potential of JDWWTP solids, and increase the fuel value of its waste solids. Not digesting the solids will increase the mass of dewatered biosolids from JDWWTP slightly and may increase the odor potential of JDWWTP solids, however.

Overall, both JDWWTP and MWWTP solids have a relatively high fuel value if they are dried sufficiently to allow for combustion. The relatively low total solids content in the dewatered solids from these WWTPs (14.5% TS at the JDWWTP and 17.3% TS at the MWWTP from grab samples) requires the evaporation of

large amounts of water, with its attendant high energy costs, before the biosolids from these WWTPs can be combusted and the fuel value can be fully recovered.

**TABLE 2
Selected Results from Ultimate & Proximate Analysis of Solids from JDWWTP and MWWTP**

Constituent	JDWWTP Sample Results ¹	MWWTP Sample Results ¹	Remarks
Percent Solids	14.5%	17.3%	Expressed as % of total mass, the remainder being water; shows better dewatering at MWWTP than at JDWWTP
Volatile Solids (Organic Matter)	73.1%	80.8%	Expressed as % of total solids above, volatile solids are a sign of fuel value and biological stability. MWWTP solids are not digested and have higher fuel value and lower stability than JDWWTP solids.
Ash Content	16.9%	10.2%	Ash is the remaining dry matter that is not volatile and consists primarily of nutrients, silica, and metals
Fixed Carbon	10.0%	9.0%	JDWWTP fixed carbon is slightly higher than MWWTP, reflecting that JDWWTP solids have been digested
Sulfur	1.0%	0.7%	Indicates higher level of sulfur in wastewater influent to JDWWTP, but sulfur is not high enough at either WWTP to pose a problem
Lower Heating Value (LHV), Btu/lb	7500	7855	Heating value of dried solids if no combustion heat is recovered
Higher Heating Value (HHV), Btu/lb	8040	8455	Heating value of dried solids if all combustion heat is recovered
Mineral Matter Free (MMF) Heating Value, Btu/lb	9506	9842	Represents total heating value of solids without interference by inert mineral matter

¹ Dewatered biosolids cake sampled on May 14, 2014, and analyses reported on June 19, 2014.

3.1 Description of Alternatives

The alternatives for biosolids management by the CBJ are being evaluated in this TM:

1. Continuation of the current practice of shipping dewatered biosolids from the JDWWTP and the MWWTP by barge to Oregon for landfill disposal (also known as the “status quo” or “base case” alternative).
2. Thermal drying of biosolids at a central facility with local disposal or marketing of the dried, Class A biosolids product.
3. Thermal drying of biosolids followed by combustion (incineration) of the biosolids to recover heat that is then recirculated to the biosolids drying process, thus reducing the amount of purchased fuel.
4. Thermal combustion (incineration) of the biosolids in a new fluidized-bed incinerator that recovers heat from the combusted biosolids to aid in evaporation and reduce the amount of purchased fuel.

Each of the alternatives that require a new biosolids drying or incineration facility (Alternatives 2-4 above) have been evaluated based on locating new drying or incineration facility at one central location, either at the JDWWTP or the MWWTP.

The advantages and disadvantages of locating new facilities at the MWWTP or the JDWWTP are:

1. **MWWTP Location Advantage:** The MWWTP currently produces 79% of CBJ’s biosolids, with most of the future growth in Juneau predicted to be in the MWWTP service area. Locating central biosolids processing facilities at the MWWTP would reduce the truck traffic and associated costs of cross-town hauling of dewatered biosolids, since only about 20% of CBJ’s biosolids would have to be transported from the JDWWTP to the MWWTP.
2. **MWWTP Location Advantage:** The MWWTP is closer to the Capital Landfill than the JDWWTP, which is the primary disposal option for the dried biosolids or ash that would be produced by these alternatives, so there would be less vehicle mileage for hauling dried product or ash.
3. **JDWWTP Location Advantage:** The MWWTP is located in the Mendenhall Valley, which is currently a non-attainment area for particulate matter in air emissions. A biosolids dryer or combustion unit may need tighter air emissions controls and obtaining an air emissions permit may be more difficult at MWWTP than JDWWTP, especially since the JDWWTP previously had an air emissions permit for the fluidized-bed incinerator (FBI) that has been decommissioned.
4. **JDWWTP Location Advantage:** The JDWWTP has more space available onsite for locating a new biosolids facility than the MWWTP, which only has the location of an existing building (called the ABF Building) for siting new biosolids facilities. A new biosolids facility at the MWWTP would therefore require demolition of an existing structure, while a new biosolids facility could be built at the JDWWTP with minimal demolition.
5. **JDWWTP Location Advantage:** The JDWWTP does not have neighbors in close proximity like the MWWTP does. The MWWTP neighbors have periodically filed complaints related to odors from the MWWTP. It is believed that the JDWWTP would be less subject to odor and nuisance complaints than the MWWTP, due to its location in an industrial zone next to a shipping dock and more land available for a buffer zone.

Recognizing the possibility that a central biosolids facility may be located at the JDWWTP or the MWWTP, a Benefit/Cost analysis was developed for the two alternative locations, as described later in this TM.

The following subsections describe each of the technical alternatives in more detail. The first alternative assumes that CBJ will continue its current practice as described below. The other three alternatives assume that new facilities for handling biosolids will be built at either the MWWTP or the JDWWTP.

3.1.1 Alternative 1 - Continuing the Transport and Landfilling of Dewatered Biosolids

Since the fluidized-bed incinerator (FBI) at the JDWWTP was decommissioned in 2011, CBJ has been landfilling all of its dewatered biosolids. Some of the biosolids have been landfilled at the local Capital Landfill in Juneau, but most of the biosolids are shipped by barge, rail, and truck to the Columbia Ridge Landfill in Arlington, Oregon. A summary of biosolids production and disposal in Calendar Year (CY) 2013 is shown in Table 3.

Table 3 indicates that 6,992 WT of biosolids were produced at CBJ’s two WWTPs, based on WWTP monthly operating reports, as shown in the 2nd column. Biosolids disposal records from WM are shown in the next two columns of Table 3. They indicate that as recently as July 2013, significant quantities of biosolids (430 WT) were disposed of locally at the Capital Landfill in Juneau. The average tipping fee for biosolids disposed of at the Capital Landfill was reported to be \$88 per WT. The average fee for biosolids transport by barge and rail and disposal at the Columbia Ridge Landfill in Oregon was reported to be \$140 per WT in 2013, but that fee was recently increased to \$215 per WT.

The reason given for rejection of biosolids by the Capital Landfill has been odors from the dewatered biosolids, which prompted complaints from Capital Landfill’s neighboring commercial developments. It is not believed that odors from the biosolids can be mitigated unless a new process such as heat-drying or incineration is installed to further treat the dewatered biosolids.

TABLE 3

Summary of CBJ Biosolids Disposal Amounts in Wet Tons (WT) in Calendar Year (CY) 2013

Month in CY 2013	Biosolids Production, from WWTP Records, WT	Disposal at Capital Landfill in Juneau, WT	Disposal at Columbia Ridge Landfill in Oregon, WT	Total Biosolids Disposed, from WM Records, WT
January	526	35	212	247
February	697	0	372	372
March	642	0	602	602
April	611	191	431	622
May	657	128	821	949
June	539	0	558	558
July	577	430	274	704
August	610	0	491	491
September	524	0	368	368
October	702	0	810	810
November	442	0	637	637
December	465	0	458	458
Total WT Biosolids Recorded for CY 2013	6,992	784	6,033	6,817

As shown in Table 3, there are variances between the monthly totals of dewatered biosolids produced, as shown in WWTP records (2nd column) and the monthly totals of biosolids disposed, shown in WM records (last column). These variances can be attributed biosolids cake storage practices prior to transport and disposal. The difference between total biosolids produced and disposed of in CY 2013 is only 2%, which again can be attributed to the timing of biosolids storage and disposal.

The current costs for landfill disposal are estimated to be approximately \$1.5 million (M) in equipment costs, prior to markups, and approximately \$1.8 M annually in O&M costs before a 10% contingency is applied. After markups on equipment costs, the capital costs associated with Alternative 1 are \$3.2 M and annual O&M costs total \$2M.

3.1.2 Alternative 2 - Thermal Drying Technology

In the most general terms, thermal drying is the use of heat to evaporate water from wastewater residual solids. The drying system, in addition to the dryer itself, generally consists of materials handling and storage equipment, heat generation and transfer equipment, air movement and distribution equipment, emissions control equipment, and ancillary systems. Drying systems use different methods for heat transfer, including convection, conduction, and radiation heating. To some extent, multiple methods of heat transfer are used by individual systems, but they are generally categorized by their primary method of heat transfer.

Systems that primarily use convection for heat transfer are often referred to as “direct” dryers. In direct heat dryers, hot air/gas flows through a process vessel and comes into direct contact with particles of wet solids. The contact between the hot air and cold wet cake allows the transfer of thermal energy, which causes an increase in wet cake temperature and evaporation of water. The hot air/gas can be produced by almost any source of heat, but most often is produced by a gas or oil-fired furnace. Since natural gas is not available at CBJ’s WWTPs, the drying systems proposed for Juneau are based on utilizing No. 2 heating oil for fuel.

Examples of direct drying equipment are rotary drum dryers and belt dryers. Belt dryers are most popular for smaller systems that would be typical of the size needed by CBJ, because they are more readily scaled down than the rotary drying systems typical of larger WWTPs. Belt dryers are also inherently safer and simpler to operate because they operate at lower temperatures of 300°F (150 °C) as opposed to rotary dryers, which operate at 800-900°F (425-480°C). Therefore, the belt drying system is recommended for consideration by CBJ.

Belt dryers use direct contact of circulating hot air with wet sludge. Sludge is pumped or otherwise distributed onto a slowly moving horizontal belt enclosed in a housing. The wet material moves through one or more drying chambers, where the moisture is released into the circulating air. After passing through the drying chambers, the dried cake falls off from the belt onto a hopper and is conveyed to a loading or storage facility. Each drying zone has its own circulating fans and air temperature control. Excess moisture is removed from the air stream in a saturator or vented directly to atmosphere. Heat for the air circulation loop in each zone is provided in a heat exchanger by indirect contact with steam, hot water, thermal oil, or hot air serving as the heat source. The drying temperatures are controlled at approximately 300°F (150 °C) at the belt entry and at 210°F (100 °C) at the belt discharge. The sludge is heated to approximately 170°F (75 °C). The lower drying temperature is claimed to produce a less odorous air stream.

The size and shape of the dried material produced depends on shape and size of the feed and can be composed of larger fragments, non-uniform in shape, with sizes between 1 and 10 mm. Vendors have developed several types of feed systems. The most common include using an extruder and knife to produce a spaghetti-shaped pellet and providing back-mixing and a screw feeder to shape and distribute the feed evenly across the belt. Utilizing recycled dried material has also been used to produce a uniformly sized pellet. A pelletizer may be added if smaller pellets of uniform size are desired. Since the sludge is not excessively moved in this system, dust formation is reduced.

A schematic diagram of a typical belt drying system is shown in Figure 1, and a photograph of the dried biosolids product typical to a belt drying system is shown in Figure 2.

The most common and prevalent belt-drying system worldwide is manufactured by Kruger, a division of Veolia Technologies. CH2M HILL worked with Kruger to provide a conceptual design and preliminary budget quote for this project, based on its BioCon Belt Drying system. Another advantage of the BioCon Belt Drying System is an energy recovery system (ERS) that Kruger developed to combust the dried biosolids and recycle the heat energy from combustion back to the dryer. The belt dryer with energy-recovery combustion furnace is described in the next subsection.

3.1.3 Alternative 3 - Thermal Drying followed by Incineration for Heat Recovery

The Kruger BioCon - Energy Recovery System (ERS) process utilizes drying to substantially decrease the water content of the sludge prior to incineration. Energy is recovered by using the dried biosolids as fuel for the furnace, which in turns heats the air that dries the biosolids. Wood pellets can also be used whenever there are not sufficient dried biosolids for a fuel source. Additional energy is recovered by a heat exchanger system which extracts heat from the water removed by drying. The final product of the furnace is an inert ash at > 98% solids content. Alternatively, the dryer can operate without the furnace and produce dried biosolids pellets at 90% solids as described above in Alternative 2, but in that case, No. 2 heating oil is the only fuel used for providing the heat to dry to the biosolids.

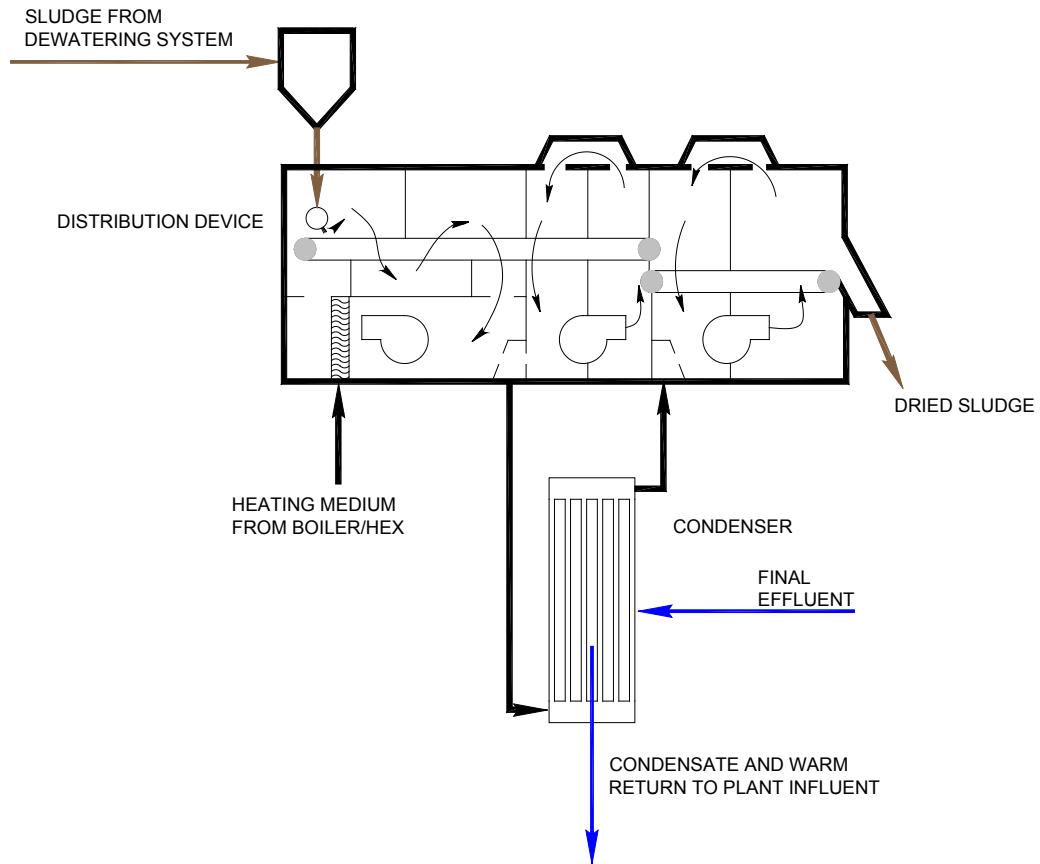

FIGURE 1
Belt Drying Process Schematic



FIGURE 2
Dried Biosolids Product from a Belt Dryer (courtesy of Kruger)

Supplemental fuel for the furnace is still needed for the BioCon-ERS dryer, because of the relatively high water content of biosolids produced by the belt filter presses at JDWWTP and MWWTP. Heat is recovered from the water in the dryer exhaust and used to preheat the biosolids going into the dryer, but the air from the furnace is the primary source of heat to the dryer. The dryer and furnace exhausts are scrubbed to remove any pollutants and discharged to the atmosphere. The resulting ash can be mixed with soil and placed in the landfill or used as a fly ash substitute in construction projects using concrete. If the dried pellets (Figure 2) are not incinerated, they may be used as fertilizer or soil amendment.

Figure 3 illustrates the Kruger BioCon-ERS process. Dewatered sludge is stored in the sludge silo until there is enough to conduct a dryer run. Solids are pumped into an extrusion device and distributed on the belt. They are dried with hot air from the furnace which combusts dried biosolids. A photo of the furnace from a Kruger BioCon-ERS unit installed in Buffalo, Minnesota, is shown in Figure 4.

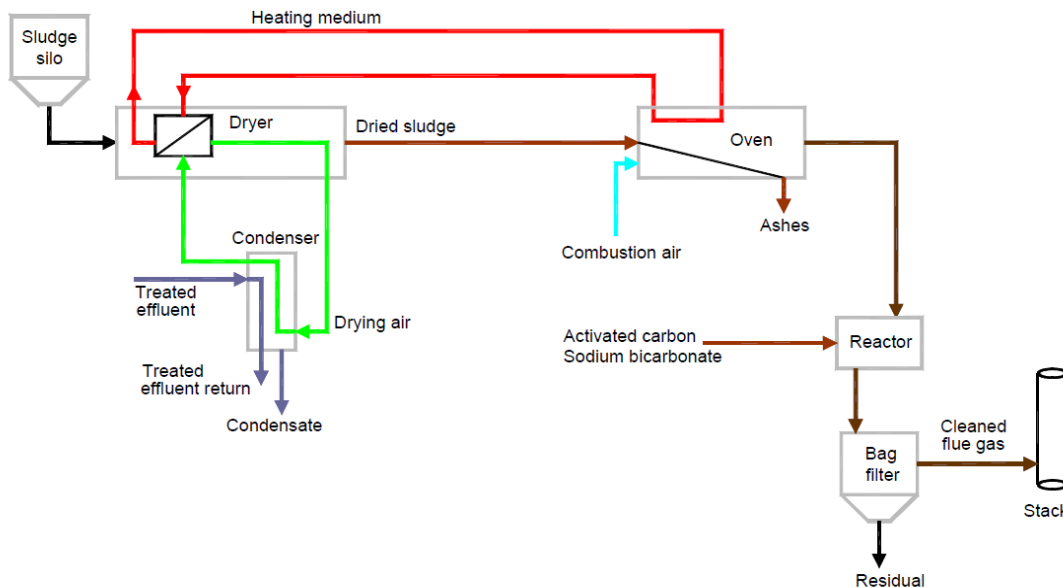

FIGURE 3
BioCon Dryer and Energy Recovery System (BioCon-ERS) Process



FIGURE 4
BioCon-ERS Incinerator Furnace

3.1.4 Alternative 4 – New Fluidized Bed Incinerator

CH2M HILL worked with Infilco-Degrement, Inc. (IDI) on recommendations for the incineration alternative. IDI manufactured and supplied the de-commissioned FBI unit at the JDWWTP, installed in the 1970's. After reviewing the reports and current status of CBJ's decommissioned and abandoned FBI unit at the JDWWTP, IDI's technical representatives concluded that the costs and risks of rebuilding the existing FBI unit to comply with present-day regulatory standards and technologies would be higher than the costs and risks of installing a completely new FBI unit that is designed to comply with all current standards. Therefore, IDI prepared a conceptual design and budget proposal to provide a new FBI unit, to be located at the MWWTP.

An FBI built to present-day EPA standards is a complex system with many components. A typical process-flow schematic for an FBI unit is shown in Figure 5.

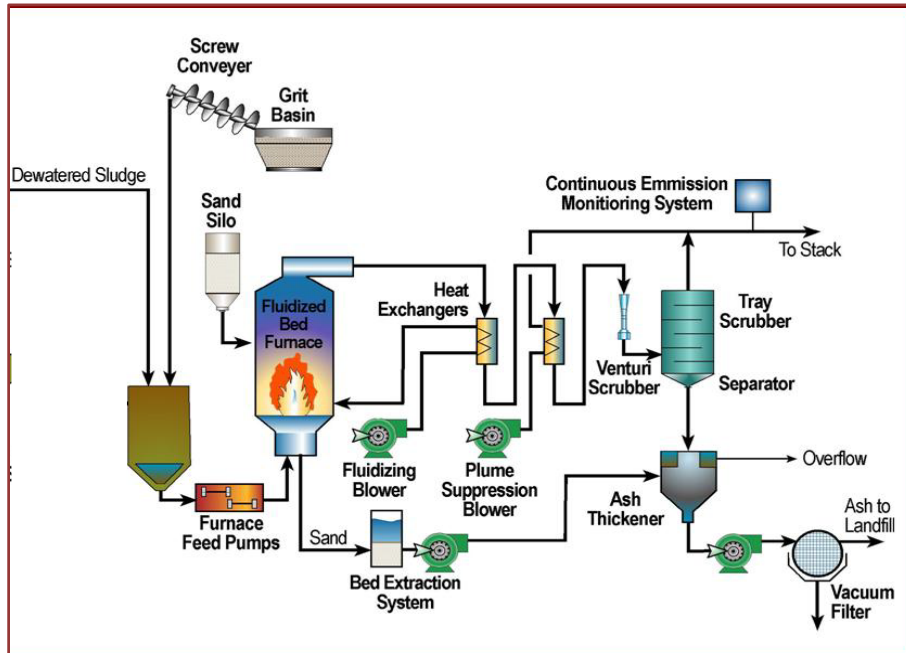

FIGURE 5
Typical Fluidized Bed Incinerator (FBI) and Accessories

The following subsections describe the alternative-evaluation methodology and results of the alternatives evaluation.

4.1 Alternatives Evaluation

The methodology used to evaluate the four alternatives described above is based on the multi-attribute utility analysis (MUA) concepts of decision science. In the MUA evaluation approach, non-monetary criteria and life-cycle cost estimates are combined to rank the alternatives according to the quantitative term of a Benefits/Cost (B/C) ratio. The evaluation methodology is described in this section.

4.1.1 Review of Evaluation Criteria, Weighting, and Ranking

In order to arrive at the B/C ranking of alternatives, the non-monetary criteria must first be developed, then weighted and ranked to arrive at quantitative rankings of each alternative according to each of the non-monetary criteria. The non-monetary criteria were initially developed and assigned relative weightings in Workshop 1. Then in Workshop 2, the criteria were revisited and revised. The weightings are numerical fractions of 1.00 that were derived in a criteria-prioritization exercise that was held among Workshop 2 participants. The results are shown in Table 4. The alternatives were later scored against the criteria based on a high probability of meeting or exceeding current and future needs (high score) or low probability of meeting or exceeding current and future needs (low score). Scoring is discussed further in Section 1.4.3.

TABLE 4

Results of Developing and Weighting Non-Monetary Criteria Used in Alternatives Evaluation

Criteria No.	Evaluation Criteria	Criteria Weights	Criteria Description
1	Ease of operation	9.1	Relative ease of operating the technologies involved in each alternative, compared to existing operations. Technologies considered easier to operate receive higher score.
2	Carbon footprint	3.6	An estimate of the amount of greenhouse gas (GHG) emissions that would be emitted as a result of implementing each of the alternatives. Lower GHG emissions receive higher score.
3	Timeline for implementation	14.5	Estimated time required to implement each alternative, relative to other alternatives. Alternatives with faster timeline receive higher score.
4	Location of the technology	1.8	Flexibility to locate the facilities involved in each alternative at any one of three possible locations (JDWWTP, MWWTP, and Capitol Landfill) relative to other alternatives. Alternatives with greater location flexibility receive higher score.
5	Logistics of transport	7.3	Ease or difficulty in which end product from each alternative (dewatered cake, dried solids, or ash) can be transported, relative to other alternatives. Alternatives with end products considered easier to transport receive higher score.
6	Public health & safety issues	18.2	Possibility of each alternative to create public health or safety issues relative to the other alternatives. Greater possibility of creating issues results in lower score.
7	Environmental & permitting issues	7.3	Likelihood of each alternative to encounter environmental or permitting problems, relative to the other alternatives. Higher likelihood of problems results in lower score.
8	Risk	16.4	The amount of risk associated with implementing each alternative, from the perspectives of new technology, process complexity, and possibility of failure during operations, relative to the other alternatives. Alternatives with higher risk receive lower score.
9	End product disposal method	10.9	Likelihood of each alternative to experience ease or difficulty with end product disposal. Greater anticipated difficulty results in lower score.
10	Energy consumption & sourcing	10.9	Estimated amount of energy and source of energy required by each alternative compared with the other alternatives. Higher score to alternatives with lower energy requirements and higher scores to alternatives that can create energy or use local energy sources.
	Total Weight	100.0	

4.1.2 Carbon Footprint Estimates and Comparisons between Alternatives

“Carbon Footprint” is the term used to express and compare a facility’s estimated contribution to global warming via its estimated emissions of greenhouse gases (GHG’s) to the atmosphere. A number of GHG’s have been identified as contributors to global warming, but the only GHG’s of consequence in wastewater treatment and biosolids management are the following three gases:

1. **Carbon dioxide (CO₂):** The most common GHG; all other GHG’s are converted to carbon-dioxide equivalents (CO₂e) when estimating total GHG emissions.
2. **Methane (CH₄):** The next most common GHG found in wastewater and biosolids after carbon dioxide, methane is the primary gas product of anaerobic respiration, and is 23 times more potent than carbon dioxide as a GHG. Therefore one unit of methane = 23 units of CO₂e.
3. **Nitrous oxide (N₂O):** The least common of the three GHG’s associated with wastewater and biosolids, nitrous oxide is a by-product of nitrification and denitrification reactions. Even though nitrous oxide is

typically emitted in smaller amounts than carbon dioxide and methane, it is 300 times more potent than carbon dioxide as a GHG. One unit of nitrous oxide = 300 units of CO₂e.

The summation of these three GHG’s, when all are converted to CO₂e, represents the total estimated Carbon Footprint of an alternative. The Total Carbon Footprint consists of direct and indirect emissions of CO₂e, which are categorized in the following three groups for purposes of estimating total GHG emissions:

1. **Scope 1 GHG emissions** – These are the direct emissions of GHG’s arising from a process or activity. However, CO₂ emitted as a result of natural biological activity, known as “biogenic CO₂ emissions” are not typically counted as part of the total carbon footprint. CO₂ emissions resulting from combustion of fossil fuels, known as “anthropogenic CO₂ emission,” are typically counted in the total carbon footprint. All of the carbon dioxide emitted from fossil-fuel based engines or processes is included in Scope 1 GHG emissions. In addition, all methane and nitrous oxide emissions from these processes are counted as Scope 1 GHG emissions, whether or not the methane or nitrous oxide is emitted from biogenic or anthropogenic sources in the processes.
2. **Scope 2 GHG Emissions** – These are indirect emissions of GHG’s resulting mostly from combustion of fossil fuels used to produce electrical power, heat, or steam that is delivered to an activity or process. Since the primary electrical power in Juneau is produced by hydro-powered turbines, the fossil fuel use in power production is negligible, and Scope 2 emissions are therefore negligible for purposes of this comparison.
3. **Scope 3 GHG Emissions** – These are indirect emissions of GHG’s resulting from the production of purchased chemicals and materials, and the uses of end products produced by an alternative. Scope 3 emissions tend to be remote from the source of an activity or process. Scope 3 GHG emissions are not considered in the following estimates of GHG emissions, or Carbon Footprint, associated with the four alternatives being evaluated.

Based on the explanations given above, only Scope 1 (Direct) GHG emissions were considered when comparing the Carbon Footprint of each alternative being evaluated. Results of the Carbon Footprint estimates are shown in Table 5.

TABLE 5
Estimated Annual Greenhouse Gas (GHG) Emissions (Carbon Footprint) of Each Alternative

Alternative	Estimated GHG Emissions (CO ₂ e) in metric tons per year (Mg/year), based on Scope 1 (Direct) GHG Emissions
1- Status Quo	2,700
2- Thermal Dryer Fueled No. 2 Heating Oil	1,900
3- Thermal Dryer + Combustion for Energy Recovery	980
4- Direct Combustion via Fluidized-Bed Incinerator (FBI)	1,200

As shown in Table 5, Alternative 3 – Thermal Dryer with Energy Recovery System, is estimated to have the lowest Scope 1 emissions of GHG’s, i.e., the smallest Carbon Footprint, of the four alternatives. The primary reason for Alternative 3 having the smallest Carbon Footprint is because it uses dried biosolids for combustion and heat recovery to help fuel the biosolids dryer, thereby substantially reducing the amount of fossil fuel (No. 2 heating oil) needed to dry or combust biosolids, when compared with Alternatives 2 and 4, respectively. Alternative 1 – Status Quo, has the highest Carbon Footprint primarily because landfilling of

biosolids results in anaerobic activity and high emissions of methane from the landfill. Additionally, fossil fuels are used to transport biosolids from the MWWTP and JDWWTP first by truck, barge, and rail, prior to being landfilled in the State of Oregon, thereby contributing to the large Carbon Footprint of Alternative 1.

4.1.3 Non-Monetary Comparison of Alternatives

Each of the four alternatives non-monetary criteria were ranked by CBJ and CH2M HILL staff. The results of these rankings are shown in Table 6 and Figure 6. A score of “5” indicates the highest possible score, in that the alternative shown would rank highest in being able to meet the criterion described. Conversely, a score of “1” indicates the lowest possible score for an alternative to satisfy that criterion.

TABLE 6
Results of Developing and Weighting Non-Monetary Criteria Used in Alternatives Evaluation

Criteria Number	1	2	3	4	5	6	7	8	9	10	Total Score
Criteria Name	Ease of Operation	Carbon Footprint	Timeline	Location	Transport	Public Health	Permitting	Risk	Disposal	Energy	
Weight	9.1	3.6	14.5	1.8	7.3	18.2	7.3	16.4	10.9	10.9	
1: Maintain Status Quo	2	1	5	1	1	1	1	4	1	2	20.7
2: Thermal Drying	3	3	3	3	3	3	3	3	3	2	26.3
3: Thermal Drying with Heat-Recovery Furnace	2	4	2	2	4	4	2	2	4	4	27.4
4: Thermal Oxidation (Incineration)	2	4	2	2	4	4	1	3	4	2	26.3

A graphical depiction of the alternative rankings with respect to non-monetary criteria is shown in Figure 6.

As shown, Alternative 3 (Dryer and Heat-Recovery Furnace), ranked highest in non-monetary terms, Alternative 2 (Thermal Drying), followed by Alternative 4 (Incineration) ranked next highest, and finally, ranked last, is Alternative 1 (Continued Status Quo of Landfill Disposal). The non-monetary criteria rankings shown in Table 6 and Figure 6 apply to either the MWWTP or JDWWTP facility location.

The cost estimates for each alternative change slightly depending on whether the biosolids treatment facility is located at the MWWTP or JDWWTP, as described in the next section of this TM.

4.1.4 Methodology for Cost Estimation

Cost estimates including capital costs, annual operation and maintenance (O&M) costs, and net present value, also were developed. All costs were derived using the same level of estimating accuracy and are therefore comparable. Actual construction costs may differ from the estimates presented, depending on specific design requirements and the economic climate at the time a project is bid. The American Association of Cost Engineers (AACE) has developed levels of accuracy for various stages of construction cost estimation. The estimates produced for the current comparison are Class 5, with a corresponding project definition level of 0-2% and expected level of accuracy of 20-50% below and 30-100% above the cost given.

Basic cost assumptions are shown in Table 7.

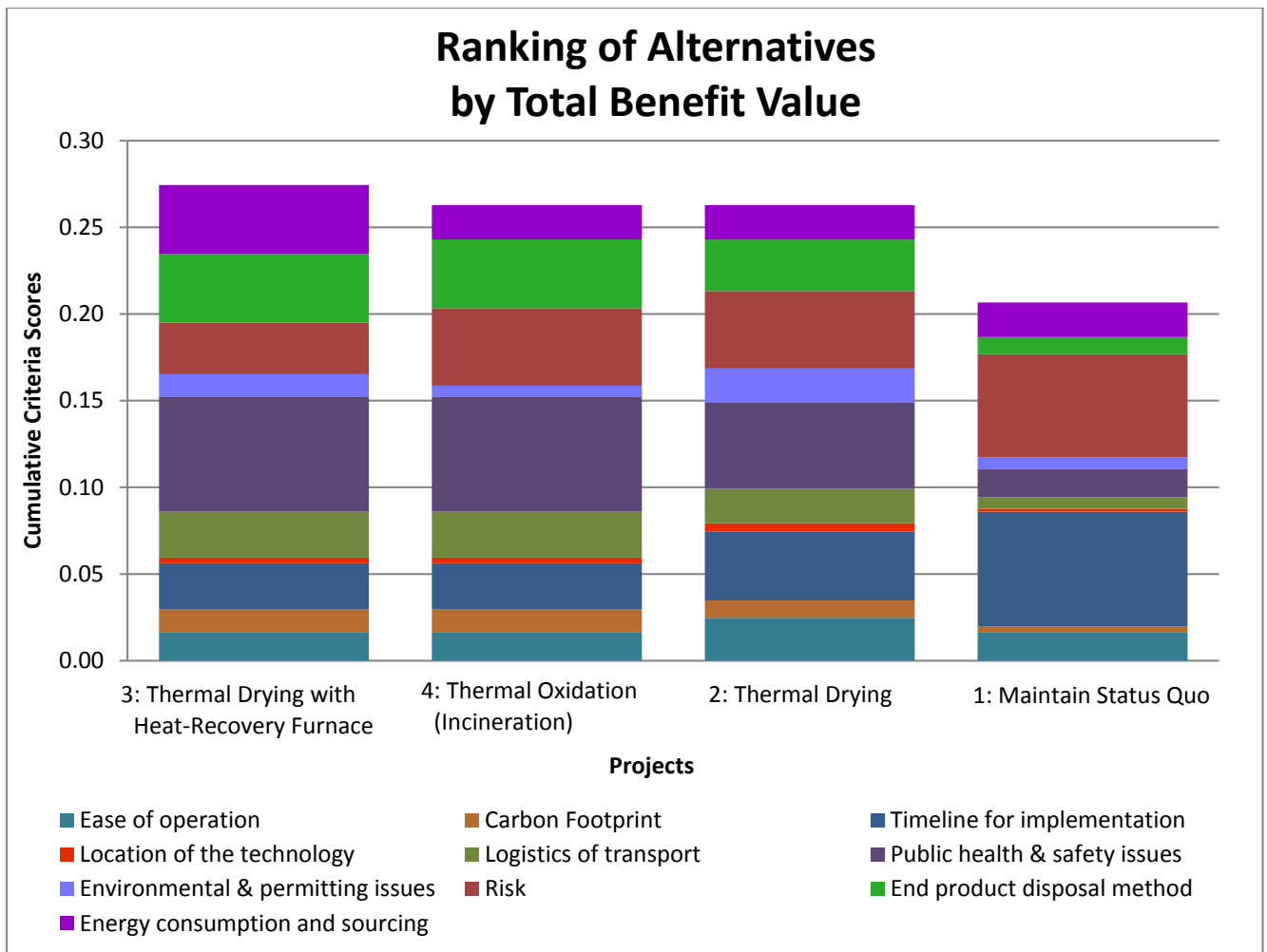

FIGURE 6
Stacked Bar Chart Display of Non-monetary Criteria Rankings of Alternatives 1-4

TABLE 7
CBJ Reference Unit Costs

Effective Discount Rate, %	3%
Inflation Rate	2%
Discount Rate, %	5%
Planning Period (and Finance Period), years	20
Power Cost, \$/kWH	\$0.0750 ¹
Staffing Cost, \$/hr	\$45.00
Staffing Cost, \$/FTE/yr	\$93,600
Building Cost (with odor control), \$/sf	\$200
No. 2 Fuel Oil \$/MMBtu	\$31

¹ Current Cost from CBJ.

4.1.5 Cost Comparison of Alternatives

Capital cost estimates for each of the alternatives are included in Table 8 and Table 9. Capital cost components for alternatives 2-4 were taken directly from vendor provided information. For the Status quo option, it is assumed that some investment in additional equipment would be required and a placeholder amount has been included. Other costs and markups have been calculated as a percentage of the capital investment, based on standard market practice. The capital costs vary slightly depending on whether the alternative would be located at the MWWTP or JDWWTP, as shown by comparing Tables 8 and 9. For example, if the biosolids treatment facility is located at the JDWWTP, it will require larger truck-loading and biosolids storage facilities, because of the greater volume of biosolids that would be trucked in from the MWWTP.

It is assumed that all capital costs are incurred over the initial two years of the project period. Then annual O&M costs are projected over the 20-year life-cycle. Cost estimates were reviewed and revised in Workshop 2.

The construction cost estimates shown in Tables 8 and 9 are conservative and include large contingencies, which are required for Class 5 cost estimates.

The annual Operations and Maintenance (O&M) costs shown in Table 10 and Table 11 were also taken directly from vendor provided information for alternatives 2-4 and using the unit costs shown in Table 7. An annual maintenance and repairs allocation was included in each of the vendor quotes to address wear and tear of equipment. The O&M costs for the status quo option are based on estimates of hauling and landfill costs per wet ton and may not accurately depict all of the costs currently incurred by CBJ. Similar to capital costs, O&M costs for each facility location are slightly different because the amounts of biosolids trucked between WWTPs differs depending on location, as shown by comparing Tables 10 and 11.

The total combined cost of capital investment and O&M was then summarized to calculate the net present worth of each alternative, assuming a 20-year planning period. The total cost of each alternative in today's dollars is shown in Table 12 for the MWWTP facility location, and Table 13 for the JDWWTP facility location.

A graphical depiction of these values is provided in Figure 7 and Figure 8, which show the breakdown of capital vs. O&M costs for each alternative. In order to create a meaningful comparison for discussion, all of the new alternatives are shown relative to the status quo alternative, which is represented as a baseline 100% relative cost. Figure 7 represents the MWWTP facility location, and Figure 8 represents the JDWWTP location.

4.1.6 Benefit-cost Comparison of Alternatives

The non-monetary criteria discussed in Section 4.1.3 were then combined with the total costs to produce a Benefit-cost score, shown in Tables 14 and 15, for the MWWTP and JDWWTP facility locations, respectively. In this evaluation, following the traditional procedure for Benefit/Cost evaluations, the total non-monetary scores were assigned a 50% weighting and the NPV scores were assigned the remaining 50% weighting in computing the Benefit/Cost scores of each alternative. As with the O&M and capital cost comparisons, each of the new alternatives is shown as having a higher or lower benefit-cost score than the Status Quo alternative, which is assigned a 100% baseline score.

Figures 9 and 10 depict the relative Benefit/Cost scores of each alternative in bar chart format.

As shown in the figures and tables above, Alternative 2 (Thermal Drying) and Alternative 3 (Thermal Drying with Energy-Recovery System) are in a virtual tie for highest rank when all factors are considered, with Alternatives 1 and 4 ranking markedly lower than Alternatives 2 and 3. The next section summarizes the rationale for recommending one alternative among these two, highest-ranking alternatives.

5.1 Recommended Alternative

The Benefit/Cost analysis conducted in the previous section concluded that the following two alternatives are virtually tied with the highest Benefit/Cost Scores:

- **Alternative 2** – Thermal Drying
- **Alternative 3** – Thermal Drying with Heat-Recovery Furnace (energy recovery system)

The Non-monetary Benefits comparison shown in Figure 6 concluded that Alternative 3 scored the highest, while the cost comparisons shown in Tables 12 and 13 indicate that Alternative 2 has a slightly lower NPV than Alternative 3. There is a marked contrast, however, between Alternatives 2 and 3 when their relative capital costs and O&M costs are compared as shown in Figures 7 and 8. Alternative 2 has a significantly lower capital cost and significantly higher O&M cost than Alternative 3.

There are some technology and regulatory risks associated with Alternative 3 that are not associated with Alternative 2. For example, Alternative 3 is still considered innovative technology because there is only one other facility in North America that uses a thermal dryer with heat-recovery furnace, which is located in Buffalo, Minnesota. Also, there may be air-emissions permitting challenges associated with Alternative 3, which involves combustion of biosolids, which compared to Alternative 2, which only requires drying of biosolids.

The recommended alternative depends largely on CBJ's access to sufficient capital to fund the additional equipment required for Alternative 3, namely the heat-recovery furnace equipment and accessories. If CBJ has sufficient capital funds to pay for the higher capital cost of Alternative 3, then substantial annual savings can be achieved by reduction of O&M costs associated with Alternative 3. Also, if an opportunity exists to defray the capital costs through grant funding, Alternative 3 would be the most desirable alternative to implement, because the investment in higher capital for Alternative 3 would substantially reduce CBJ's annual O&M costs.

Therefore, **Alternative 3** – Thermal Drying with Heat-Recovery Furnace (energy recovery system) is the recommended alternative for implementation.

TABLE 8

Capital Cost Breakdown of Alternatives for MWWTP Facility Location

Capital Cost Component	Alternative 1	Alternative 2	Alternative 3	Alternative 4
ABF Building Demolition		\$75,000	\$75,000	\$75,000
Thermal Dryer		\$2,898,000		
Thermal Dryer/Energy Recovery Furnace			\$5,840,000	
Fluidized Bed Incineration				\$14,342,178
Post Dewatering sludge storage		\$500,000	\$500,000	\$500,000
Dried Product/Ash Silo		\$500,000	\$500,000	\$250,000
General solids conveyance		\$500,000	\$500,000	\$500,000
New Building		\$2,240,000	\$2,240,000	\$2,240,000
Rolling stock and equipment	\$1,500,000			
<i>Subtotal Construction/Installation Cost</i>	\$1,500,000	\$6,713,000	\$9,655,000	\$17,907,178
Additional Project Costs				
Site Work		\$134,260	\$193,100	\$358,144
Installation (10% of equipment cost)		\$289,800	\$584,000	\$1,434,218
Plant Computer System, I&C		\$335,650	\$482,750	\$895,359
Yard Electrical		\$537,040	\$772,400	\$1,432,574
Yard Piping		\$335,650	\$482,750	\$895,359
<i>Subtotal</i>	\$0	\$1,632,400	\$2,515,000	\$5,015,653
Other Markups				
Overhead	\$150,000	\$834,540	\$1,217,000	\$2,292,283
Profit	\$82,500	\$458,997	\$669,350	\$1,260,756
Mobilization/Bonds/Insurance	\$86,625	\$481,947	\$702,818	\$1,323,794
Contingency (30%)	\$545,738	\$3,036,265	\$4,427,750	\$8,339,899
Location Adjustment Factor (18% above 100% for CBJ)	\$425,675	\$2,368,287	\$3,453,645	\$6,505,121
<i>Subtotal</i>	\$1,290,538	\$7,180,036	\$10,470,563	\$19,721,853
Non-Construction Costs				
Permitting	\$55,811	\$310,509	\$452,811	\$852,894
Engineering	\$251,148	\$1,397,289	\$2,037,651	\$3,838,022
Services During Construction		\$776,272	\$1,132,028	\$2,132,234
Commissioning & Startup		\$465,763	\$679,217	\$1,279,341
Land / ROW				
Legal / Admin	\$55,811	\$310,509	\$452,811	\$852,894
<i>Subtotal Non-Construction</i>	\$362,770	\$3,260,342	\$4,754,518	\$8,955,384
Total Construction Cost Estimates	\$3,200,000	\$18,800,000	\$27,400,000	\$51,600,000

TABLE 9
Capital Cost Breakdown of Alternatives for JDWWTP Facility Location

Capital Cost Component	Alternative 1	Alternative 2	Alternative 3	Alternative 4
Incinerator Building Demolition		\$75,000	\$75,000	\$ 75,000
Thermal Dryer		\$2,898,000		
Thermal Dryer/Energy Recovery Furnace			\$5,840,000	
Fluidized Bed Incineration				\$14,342,178
Post Dewatering sludge storage		\$1,000,000	\$1,000,000	\$1,000,000
Dried Product/Ash Silo		\$500,000	\$500,000	\$250,000
General solids conveyance		\$500,000	\$500,000	\$500,000
New Building		\$2,240,000	\$2,240,000	\$2,240,000
Rolling stock and equipment	\$1,500,000			
<i>Subtotal Construction/Installation Cost</i>	\$1,500,000	\$7,213,000	\$10,155,000	\$18,407,178
Additional Project Costs				
Site Work		\$144,260	\$203,100	\$368,144
Installation (10% of equipment cost)		\$289,800	\$584,000	\$1,434,218
Plant Computer System, I&C		\$360,650	\$507,750	\$920,359
Yard Electrical		\$577,040	\$812,400	\$1,472,574
Yard Piping		\$360,650	\$507,750	\$920,359
<i>Subtotal</i>	\$0	\$1,732,400	\$2,615,000	\$5,115,653
Other Markups				
Overhead	\$150,000	\$894,540	\$1,277,000	\$2,352,283
Profit	\$82,500	\$491,997	\$702,350	\$1,293,756
Mobilization/Bonds/Insurance	\$86,625	\$516,597	\$737,468	\$1,358,444
Contingency (30%)	\$545,738	\$3,254,560	\$4,646,045	\$8,558,194
Location Adjustment Factor (18% above 100% for CBJ)	\$425,675	\$2,538,557	\$3,623,915	\$6,675,391
<i>Subtotal</i>	\$1,290,538	\$7,696,251	\$10,986,778	\$20,238,068
Non-Construction Costs				
Permitting	\$55,811	\$332,833	\$475,136	\$875,218
Engineering	\$251,148	\$1,497,749	\$2,138,110	\$3,938,481
Services During Construction		\$832,083	\$1,187,839	\$2,188,045
Commissioning & Startup		\$499,250	\$712,703	\$1,312,827
Land / ROW				
Legal / Admin	\$55,811	\$332,833	\$475,136	\$875,218
<i>Subtotal Non-Construction</i>	\$362,770	\$3,494,747	\$4,988,923	\$9,189,789
Total Construction Cost Estimates	\$3,200,000	\$20,100,000	\$28,700,000	\$53,000,000

TABLE 10
Annual O&M Cost Breakdown of Alternatives for MWWTP Facility Location

O&M Costs	Alternative 1	Alternative 2	Alternative 3	Alternative 4
Cake Hauling Between plants		\$34,188	\$34,188	\$35,328
Truck loading of product (\$20/wet ton)	\$142,194			
Hauling of product (\$20/ wet ton)	\$142,194	\$24,533	\$3,312	\$3,312
Landfill of product (\$215/wet ton for combined barge/landfill)	\$1,531,355			
Product sales				
Dryer O&M		\$181,942	\$304,569	
Incinerator O&M				\$380,444
Electricity		\$30,985	\$48,153	
Fuel		\$640,406 ¹	\$139,166 ²	\$197,309 ¹
<i>Total OM \$/yr</i>	\$1,816,258	\$912,055	\$529,388	\$616,392
Contingency on O&M cost (10%)	\$181,626	\$91,205	\$52,939	\$61,639
Total Avg Annual OM \$/yr (Current Unit Prices)	\$1,998,000	\$1,003,000	\$582,000	\$678,000

¹ No. 2 Fuel Oil

² Supplemental Wood Chips

TABLE 11
Annual O&M Cost Breakdown of Alternatives for JDWWTP Facility Location

O&M Costs	Alternative 1	Alternative 2	Alternative 3	Alternative 4
Cake Hauling Between plants		\$108,263	\$108,263	\$111,872
Truck loading of product (\$20/wet ton)	\$142,194			
Hauling of product (\$20/ wet ton)	\$142,194	\$24,533	\$3,312	\$3,312
Landfill of product (\$215/wet ton for combined barge/landfill)	\$1,531,355			
Product sales				
Dryer O&M		\$181,942	\$304,569	
Incinerator O&M				\$380,444
Electricity		\$30,985	\$48,153	
Fuel		\$640,406 ¹	\$139,166 ²	\$197,309 ¹
<i>Total OM \$/yr</i>	\$1,816,258	\$986,130	\$603,463	\$692,936
Contingency on O&M cost	\$181,626	\$98,613	\$60,346	\$69,294
Total Avg Annual OM \$/yr (Current Unit Prices)	\$1,998,000	\$1,085,000	\$664,000	\$762,000

¹ No. 2 Fuel Oil

² Supplemental Wood Chips

TABLE 12

Net Present Value (NPV) Cost Estimates of the Alternatives for MWWTP Facility Location

Alternative Number	Name of Alternative	NPV of Capital Cost	NPV of Annual O&M Costs	Total NPV
1	Maintain Status Quo	\$2,700,000	\$32,200,000	\$34,900,000
2	Thermal Drying	\$18,300,000	\$16,100,000	\$34,400,000
3	Thermal Drying with Heat-Recovery Furnace	\$26,600,000	\$9,400,000	\$36,000,000
4	Thermal Oxidation (Incineration)	\$50,200,000	\$10,900,000	\$61,100,000

TABLE 13

Net Present Value (NPV) Cost Estimates of the Alternatives for JDWWTP Facility Location

Alternative Number	Name of Alternative	NPV of Capital Cost	NPV of Annual O&M Costs	Total NPV
1	Maintain Status Quo	\$2,700,000	\$32,200,000	\$34,900,000
2	Thermal Drying	\$19,500,000	\$17,500,000	\$37,000,000
3	Thermal Drying with Heat-Recovery Furnace	\$27,900,000	\$10,700,000	\$38,600,000
4	Thermal Oxidation (Incineration)	\$51,500,000	\$12,300,000	\$63,800,000

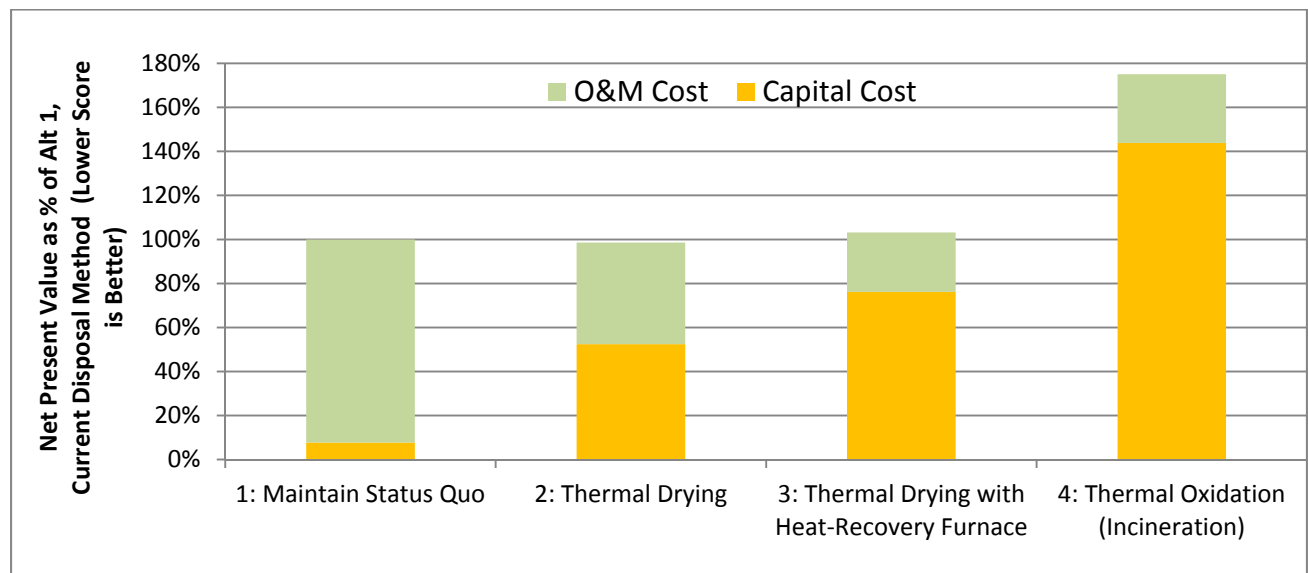

FIGURE 7

Net Present Value of Capital and O&M Costs for All Alternatives Relative to Status Quo Option for MWWTP Facility Location

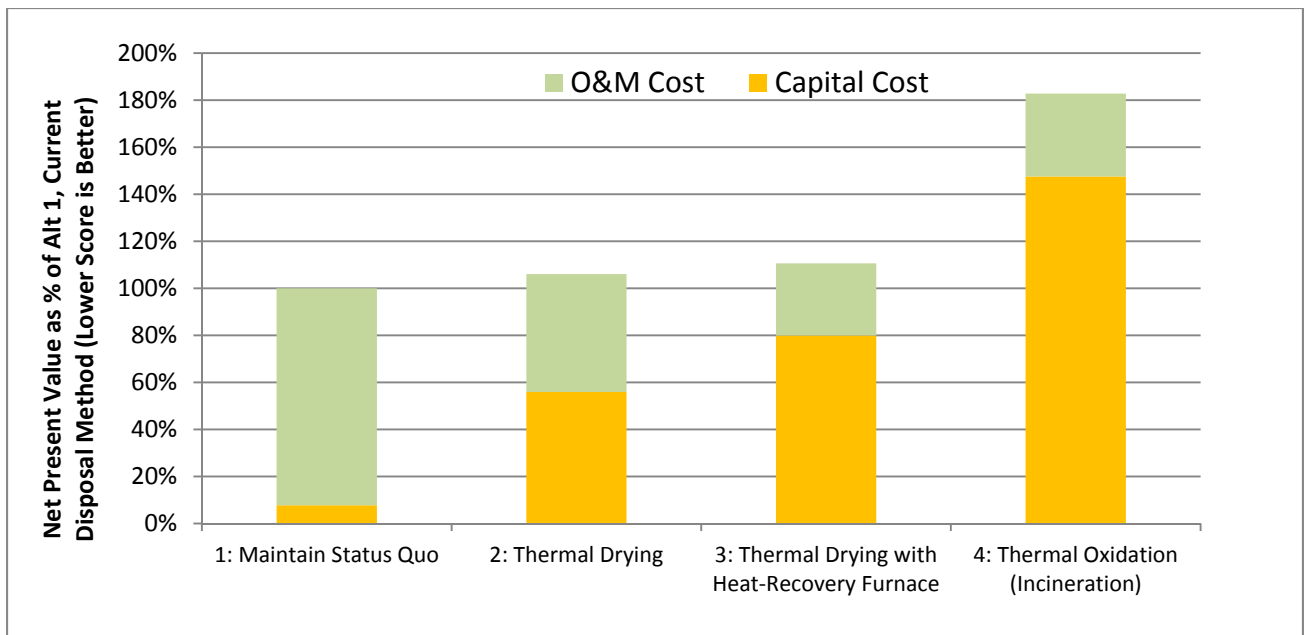

FIGURE 8
Net Present Value of Capital and O&M Costs for All Alternatives Relative to Status Quo Option for JDWWTP Facility Location

TABLE 14
Benefit-cost Score of Alternatives for MWWTP Location

Project Title	Capital & O&M NPV	Non-monetary Benefit Score	Benefit-Cost Score	Benefit-Cost Score Relative to Status Quo
1: Maintain Status Quo	\$34,900,000	20.66	0.59	100%
2: Thermal Drying	\$34,400,000	26.28	0.76	129%
3: Thermal Drying with Heat-Recovery Furnace	\$36,000,000	27.44	0.76	129%
4: Thermal Oxidation (Incineration)	\$61,100,000	26.28	0.43	73%

TABLE 15
Benefit-cost Score of Alternatives for JDWWTP Location

Project Title	Capital & O&M NPV	Non-monetary Benefit Score	Benefit-Cost Score	Benefit-Cost Score Relative to Status Quo
1: Maintain Status Quo	\$34,900,000	20.66	0.59	100%
2: Thermal Drying	\$37,000,000	26.28	0.71	120%
3: Thermal Drying with Heat-Recovery Furnace	\$38,600,000	27.44	0.71	120%
4: Thermal Oxidation (Incineration)	\$63,800,000	26.28	0.41	70%

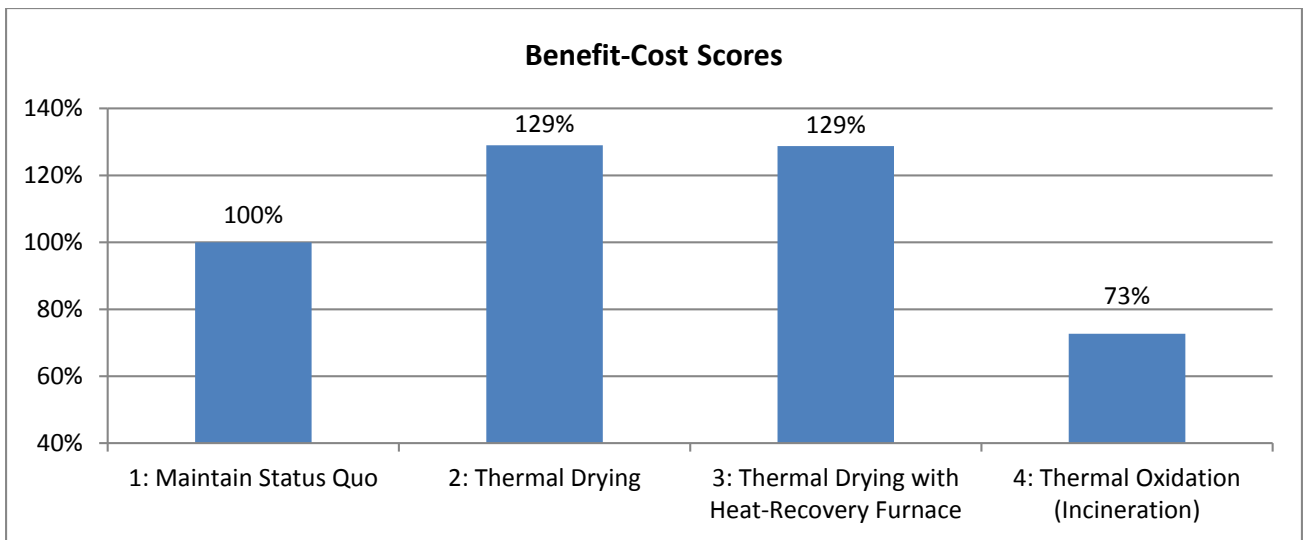

FIGURE 9
Benefit-Cost Scores for All Alternatives Relative to Status Quo Option for MWWTP Facility Location

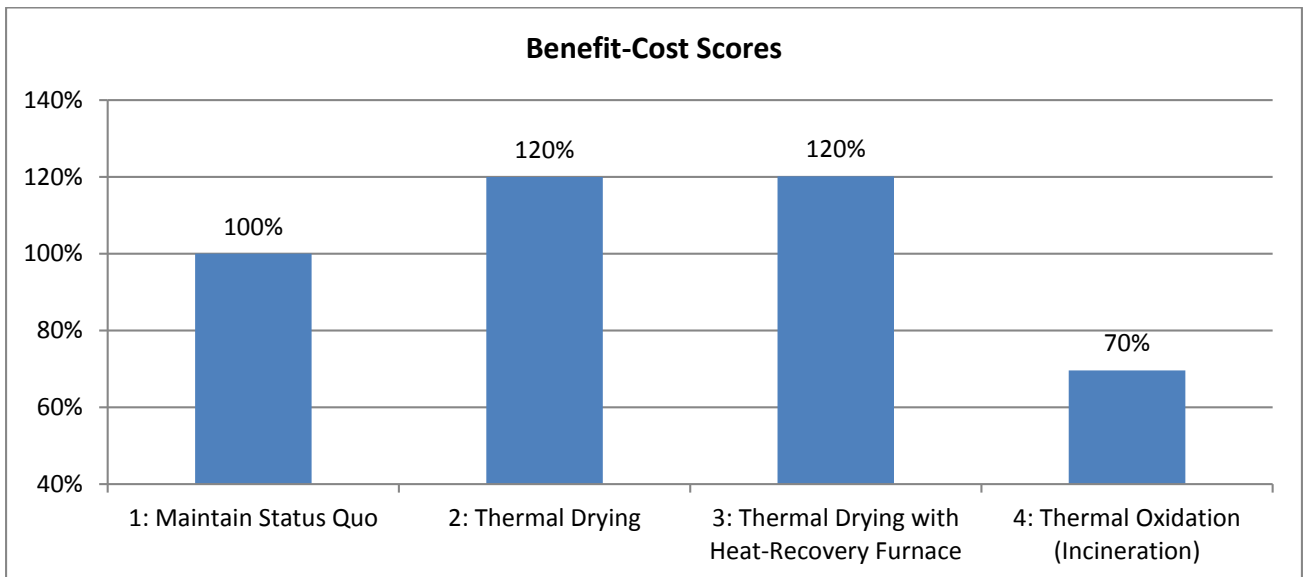

FIGURE 10
Benefit-Cost Scores for All Alternatives Relative to Status Quo Option for JDWWTP Facility Location

Biosolids Treatment and Disposal Evaluation–Phase II Long Term Plan and Operating Strategies

PREPARED FOR: City/Borough of Juneau (CBJ), Alaska

PREPARED BY: CH2M HILL

DATE: September 4, 2014

1.1 Introduction

Objectives of this Technical Memorandum 3 (TM3) are:

1. To describe the recommended alternative in detail
2. To describe potential operating strategies for the recommended plan
3. To describe phasing alternatives for the recommended plan, with associated implementation schedules.

This TM will describe the recommended long-range biosolids management plan, based on the work summarized in prior TMs 1 and 2, and the decisions made at Workshops 1 and 2.

2.1 Recommended Alternative

TM2 (Alternatives Evaluation and Results) summarized the methodology and results of the alternatives evaluation, and presented additional issues to consider in selecting and implementing an alternative. Workshop 2 was held with CBJ on July 8-9, 2014, to discuss TM2 and the results of the evaluation. CH2M HILL made revisions to TM2 to reflect the decisions of Workshop 2, and delivered the revised draft of TM2 to CBJ on July 16, 2014. Review comments on TM2 were received from CBJ on July 29, 2014. This section summarizes the current status of decisions made relative to the recommended alternative and its potential variations.

2.1.1 Results of Alternative Evaluation Workshop

The following four alternatives were evaluated in detail in TM2 and discussed in Workshop 2:

1. Continuation of the current practice of shipping dewatered biosolids from the JDWWTP and the MWWTP by barge to Oregon for landfill disposal (also known as the “**status quo**” or “base case” alternative).
2. **Thermal drying** of biosolids at a central facility with local disposal or marketing of the dried, Class A biosolids product.
3. Thermal drying of biosolids followed by combustion (incineration) of the biosolids to recover heat that is then recirculated to the biosolids drying process, thus reducing the amount of purchased fuel (**thermal drying with heat recovery**).
4. **Thermal oxidation (incineration)** of the biosolids in a new fluidized-bed incinerator that recovers heat from the combusted biosolids to aid in evaporation and reduce the amount of purchased fuel.

Alternatives 2, 3 and 4 were evaluated assuming one of two locations for a centralized biosolids management facility. In the first case, the biosolids management facility is assumed to be located at the CBJ’s Mendenhall Wastewater Treatment Plant (MWWTP). In the second case, the biosolids management facility is assumed to be located at the Juneau-Douglas WWTP (JDWWTP). Figures 1 and 2 show the results of the Benefit-Cost analysis and comparison of the four alternatives, assuming that the biosolids

management facility is located at either the MWWTP or the JDWWTP, respectively. In this Benefit-Cost Analysis, each alternative is compared with Alternative 1 (Status Quo) which was assigned a relative score of 100%. The relative benefits and costs of each alternative are each given 50% of the total score, with the result that the alternative with the best combination of low costs and high benefits shows the highest total Benefit-Cost score.

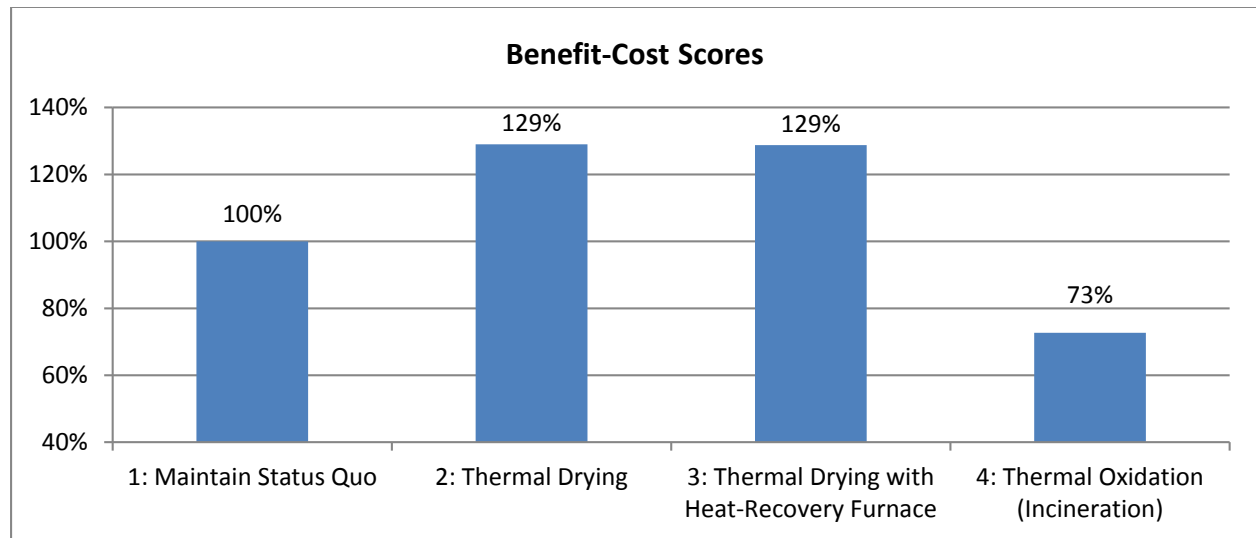

FIGURE 1
Benefit-Cost Scores of Alternatives 1-4 with Biosolids Management Facility at MWWTP

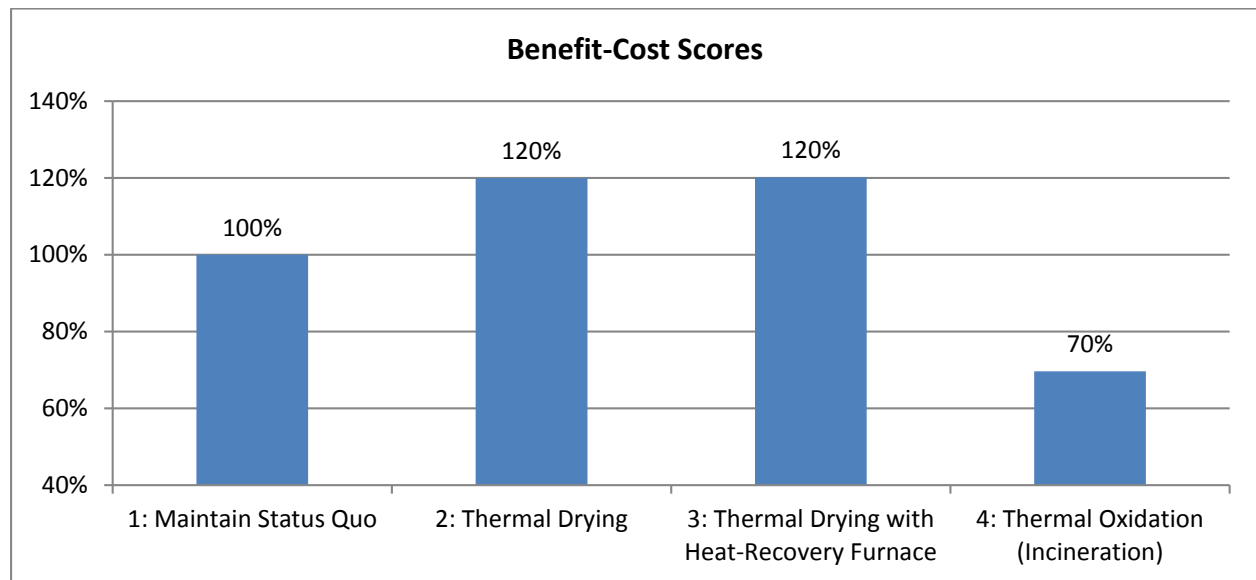

FIGURE 2
Benefit-Cost Scores of Alternatives 1-4 with Biosolids Management Facility at JDWWTP

In each case shown above, Alternatives 2 and 3 both result in higher Benefits-Cost scores than the Status Quo, by significant percentages of 26-39% higher scores, while Alternative 4 shows a significantly lower Benefits-Cost score. The differences between the Benefits-Cost scores of Alternatives 2 and 3 are minimal and smaller than the accuracy of the estimating tool.

Another factor that plays heavily into the decision-making process is a comparison of Net Present Worth (NPW) between alternatives, as shown in Figures 3 and 4. In these figures, the capital and O&M costs are further separated into annual operations and maintenance (O&M) and capital cost components. This

comparison shows that Alternatives 2 and 3 both have slightly lower NPW's than Alternative 1 (Status Quo). Although Alternative 3 has a slightly higher NPW than Alternative 2, its O&M cost component is significantly lower.

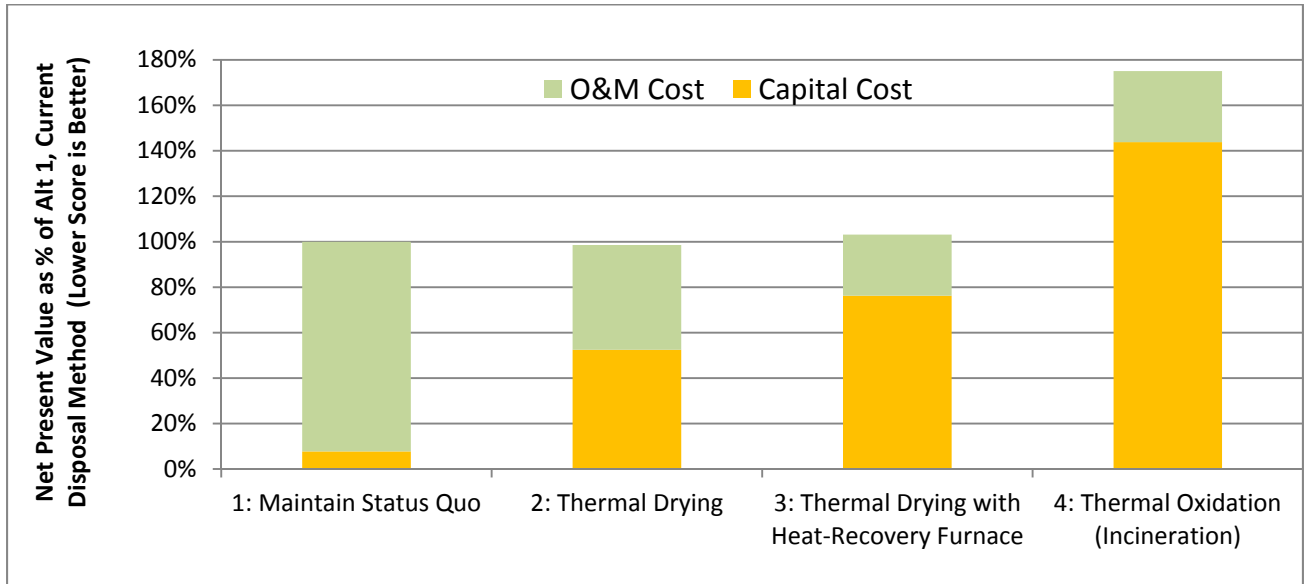

FIGURE 3
Net Present Value of Capital and O&M Costs for All Alternatives Relative to Status Quo Option for MWWTP Facility Location

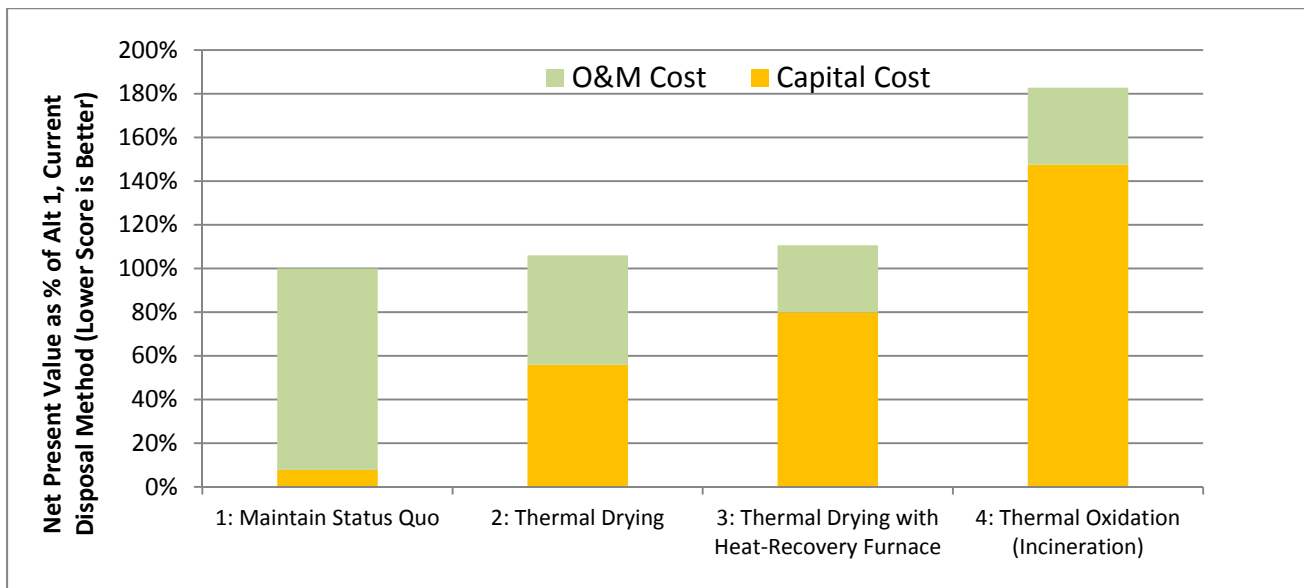

FIGURE 4
Net Present Value of Capital and O&M Costs for All Alternatives Relative to Status Quo Option for JDWWTP Facility Location

Another important factor in the comparison of alternatives is “carbon footprint,” which is an assessment of the potential for greenhouse gas (GHG) emissions associated with each alternative. A basic estimation of direct (Scope 1) GHG emissions associated with each alternative indicates that Alternative 3 has a substantially lower estimate of GHG emissions (i.e., carbon footprint) than Alternative 2. This is primarily because Alternative 2 depends on a fossil fuel (No. 2 heating oil) to dry the biosolids, while Alternative 3 creates a renewable fuel (dried biosolids pellets) that can be combusted as a fuel source, and renewable wood chips are used as a fuel supplement if the fuel value of dried biosolids is not enough to drive the drying process.

When all factors were taken into consideration including non-monetary criteria such as carbon footprint, capital costs, and annual O&M costs, **Alternative 3 – Thermal Drying with Heat-Recovery Furnace**, was selected as the most desirable long-term biosolids management alternative for Juneau going forward.

2.1.2 Description of Recommended Alternative

The recommended alternative utilizes thermal drying to substantially decrease the water content of the sludge prior to thermal oxidation. With the addition of a furnace, energy is recovered by using the dried biosolids as the primary fuel for the furnace, which in turns heats the air that dries the biosolids. Additional energy is recovered by a heat exchanger system which extracts heat from the drying process. The final product of the dryer/furnace combination is an inert ash at > 98% solids content.

Wood pellets would be needed to supplement the dried biosolids as fuel for the furnace under most operating conditions, because the dried biosolids do not always provide enough heat to dry the biosolids. The dryer could also operate using only wood pellets as fuel, and produce dried biosolids pellets at 90% solids for other beneficial uses. Finally, the dryer could use an oil burner as its heat source rather than a furnace, but in that case, No. 2 heating oil would be the only fuel used for providing the heat to dry to the biosolids, and there would not be an option for using dried biosolids or wood pellets as fuel.

The recommended alternative therefore includes a furnace that will combust biosolids and wood pellets to produce heat for drying the biosolids, thereby avoiding the use of fossil fuels in the heat drying process.

2.1.2.1 Belt Dryer

The type of dryer upon which the recommended alternative is based is a belt dryer, chosen because it was the best fit among other dryer alternatives for CBJ's projected biosolids loading rates. The belt dryer is also one of the safest dryers on the market because it operates at the lowest temperature range of available biosolids dryers.

Belt dryers use direct contact of circulating hot air with wet solids extruded onto and conveyed by a slowly moving horizontal belt housed in a metal enclosure. The wet material moves through several drying chambers, where the moisture is released into the circulating air. After passing through the drying chambers, the dried solids fall from the belt into a hopper and are conveyed to a loading or storage facility.

Each drying zone has its own circulating fans and air temperature control. Excess moisture is removed from the air stream in a saturator. Heat for the air circulation loop in each zone is provided in a heat exchanger by indirect contact with steam, hot water, thermal oil, or hot air serving as the heat source. The drying temperatures are typically controlled at approximately 300°F at the belt entry and at 210°F at the belt discharge. The solids are typically heated to 170°F. The lower drying temperature usually produces a less odorous exhaust stream, and the drying process is less prone to accidental combustion than rotary drum dryers, which operate at much higher temperatures.

Dried biosolids produced by the dryer are composed of fragments that are non-uniform in shape, with sizes between 1 and 10 mm across. A screen is sometimes used to produce a more uniform product size. A pelletizer must be added if smaller pellets of uniform size are desired. Since the sludge is not excessively moved in this system, dust formation is reduced in the dryer itself, although dust may form in subsequent handling of the dried product. Figure 5 presents a schematic diagram of a typical belt dryer system.

Belt dryers are available from Andritz, Kruger, and Huber. Kruger belt dryers were first installed in Europe in 1995, and Andritz's first belt dryer was installed in Europe in 2002. At present there are at least twenty Kruger and about the same number of Andritz belt dryers either in operation or development worldwide, while Huber follows with approximately ten belt dryer installations in operation or development worldwide. Of the worldwide installations, Kruger has five belt dryer installations in the USA, Huber has two belt dryer installations in the USA, and Andritz has no USA belt dryer installations to date.

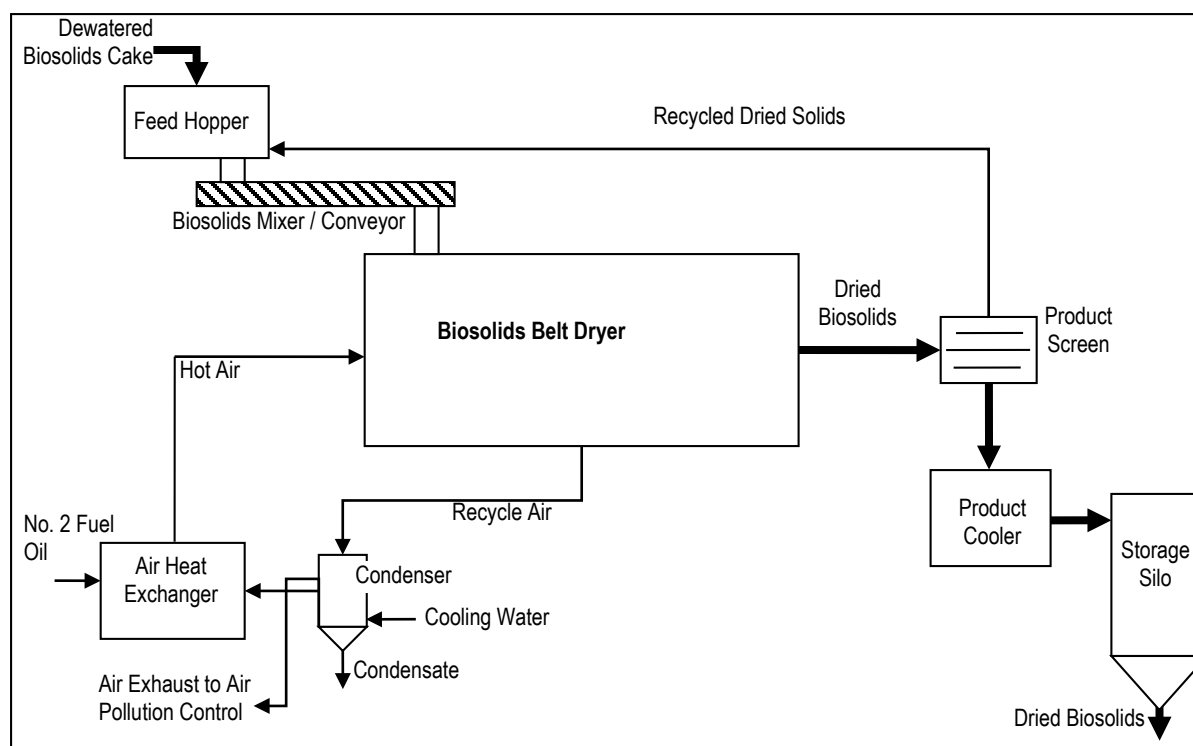

FIGURE 5
Belt Dryer Schematic Diagram

2.1.2.2 Heat-recovery Option for Belt Dryer

The belt dryer operating with a heat-recovery furnace has reduced operational costs when compared to the dryer alone. The dryer alone has a much higher external-fuel requirement, while the heat-recovery furnace can provide most of the heat needed for drying by combustion of the dried product with the heat recovered from combustion. Dewatered solids are stored in the cake-storage silo until there is enough to conduct a dryer run. Solids are pumped into an extrusion device and distributed on the belt. The cake solids are dried with hot air from the furnace which, in this case combusts dried biosolids.

The heat-recovery option requires a higher level of maintenance and also requires disposal of ash. These elements are offsetting but result in significantly lower O&M costs for the heat-recovery option when compared with the standard belt dryer. The heat value of the dried biosolids is a function of the volatile solids content of the solids, and has a large impact on the predicted operating cost. Based on the volatile solids content of 85-90% found at CBJ's WWTPs, the dried sludge will provide at least 80% of the heat requirement of the dryer. Should the total solids content of the dewatered solids increase from current values, the heat-recovery furnace may provide all of the heat requirement of the belt dryer.

Supplemental fuel for the furnace is still needed for the thermal dryer with heat-recovery furnace, because of the relatively high water content of biosolids produced by the belt filter presses at JDWWTP and MWWTP. Heat is recovered from the water in the dryer exhaust and used to preheat the biosolids going into the dryer, but the air from the furnace provides the primary source of heat to the dryer. The dryer and furnace exhausts are scrubbed to remove any pollutants and discharged to the atmosphere. The resulting ash can be mixed with soil to use in landfill cover or used as a substitute for fly ash in concrete production. If the dried pellets are not incinerated, they may be used as fertilizer or soil amendment.

Each of the belt dryer manufacturers listed above offers a heat-recovery furnace option with its belt dryer, and each of them reports at least one installation of a belt dryer with heat-recovery furnace in Europe. Only one of the three belt-dryer manufacturers has a dryer with heat-recovery furnace operating in the USA,

however, and that is Kruger. The City of Buffalo, Minnesota, has operated a Kruger belt dryer with heat-recovery furnace since 2008, and it is sized for approximately 3 MGD of wastewater flow, similar to Juneau.

Figure 6 illustrates **Alternative 3 – Thermal Drying with Energy Recovery Furnace**, based on the Kruger BioCon-ERS process, upon which most of the technical and cost-estimating information was obtained for Alternative 3.

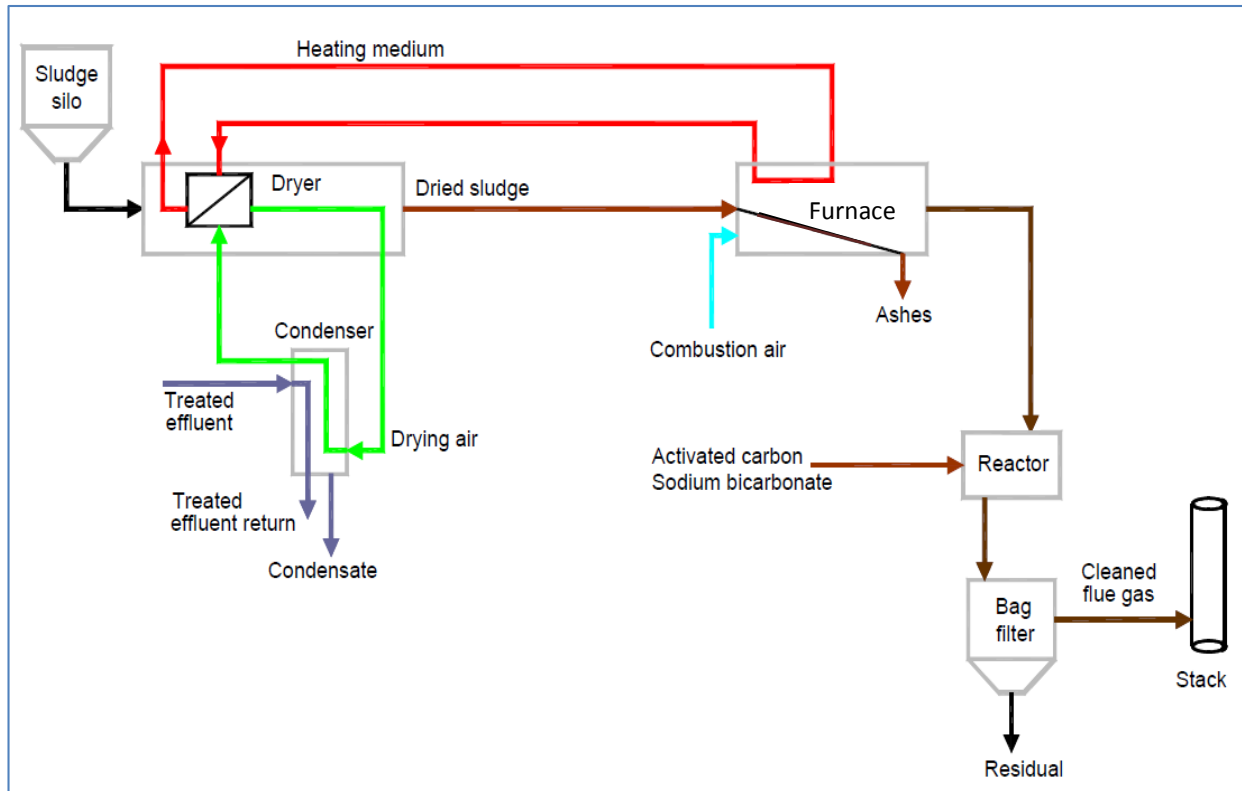

FIGURE 6
Simplified schematic Diagram of Alternative 3 – Thermal Drying with Energy Recovery Furnace, Based on Kruger BioCon-ERS Model

2.1.3 Planning and Siting Recommendations

There are two potential site locations for CBJ’s biosolids drying facility, the MWWTP or the JDWWTP. The MWWTP produces almost 80% of CBJ’s biosolids, so would be the logical choice for siting a central biosolids management facility to reduce the extent of biosolids hauling. However, the site at MWWTP is more constrained, and the Mendenhall Valley where the MWWTP is located is currently a non-attainment area for air emissions, which would likely increase the cost of permitting and air-emissions technology at the MWWTP. The JDWWTP site has more available space and a wider buffer from its adjacent properties, and is not as sensitive as the MWWTP site with respect to its air-permitting requirements.

The advantages and disadvantages of locating new facilities at the MWWTP or the JDWWTP are summarized below in Table 1:

**TABLE 1
Advantages/Disadvantages of Biosolids Facility Location**

Comparison Criteria	Mendenhall WWTP	Juneau-Douglas WWTP
Sludge Transported Annually	1710 wet tons	5413 wet tons
Distance to Landfill (Disposal Site)	4 miles	7 miles
Air Emissions/Permitting Issues	Complex (close neighbors, Mendenhall Valley non-attainment)	Not as complex (industrial district, had prior air emissions permit)
Infrastructure Needs	Need new building, must demolish existing building, constrained site	May be able to reuse part of Incineration/Dewatering Building, more space available
Construction Timeline	Likely longer due to restricted site access and more complex permitting	Likely shorter due to easier site access and less complex permitting
Resident/Neighbor Impacts	Nearby commercial and residential neighbors on all sides	Industrial area, no nearby residences, near cruise ship docks and 1 mile from downtown Juneau
NPV of Capital Costs	\$26.6 million	\$27.9 million
NPV of O&M Costs	\$9.4 million	\$10.7 million

Locating a new biosolids drying facility at the MWWTP appears to be less costly than locating a biosolids drying facility at the JDWWTP at this point, because nearly 80% of CBJ’s biosolids are produced at the MWWTP. Therefore, the JDWWTP facility capital cost includes larger bins for storing imported solids, and its O&M costs reflect higher volumes of dewatered solids that have to be transported from MWWTP to JDWWTP.

The JDWWTP facility location has several non-monetary advantages over the MWWTP location, however. It does not have neighbors in close proximity like the MWWTP does. The MWWTP neighbors have periodically filed complaints related to odors from the MWWTP. It is believed that the JDWWTP would be less subject to odor and nuisance complaints than the MWWTP, due to its location in an industrial zone next to a shipping dock and more land available for a buffer zone. Also it is believed that air emissions permitting may be less complex at the JDWWTP because a permitted incinerator previously operated on the site, and the MWWTP is in a non-attainment area for air particulates, potentially making an air emissions permit at MWWTP more stringent and difficult to obtain.

Figure 7 indicates where a new thermal drying facility with energy-recovery furnace could be located on the JDWWTP site. The system’s space requirements are approximately 95 feet long by 75 feet wide. It is advantageous to locate the drying facility as close as possible to the dewatering equipment. The existing dewatering equipment at JDWWTP, which would remain in place, is represented by the small rectangle in the bottom left corner of the existing incinerator building. The new thermal drying facility is located just to the right of the existing dewatering equipment in Figure 7. The portion of the existing building that houses the de-commissioned incinerator would likely have to be demolished, and the new thermal drying facility installed inside a new building in its place, as shown in Figure 7.

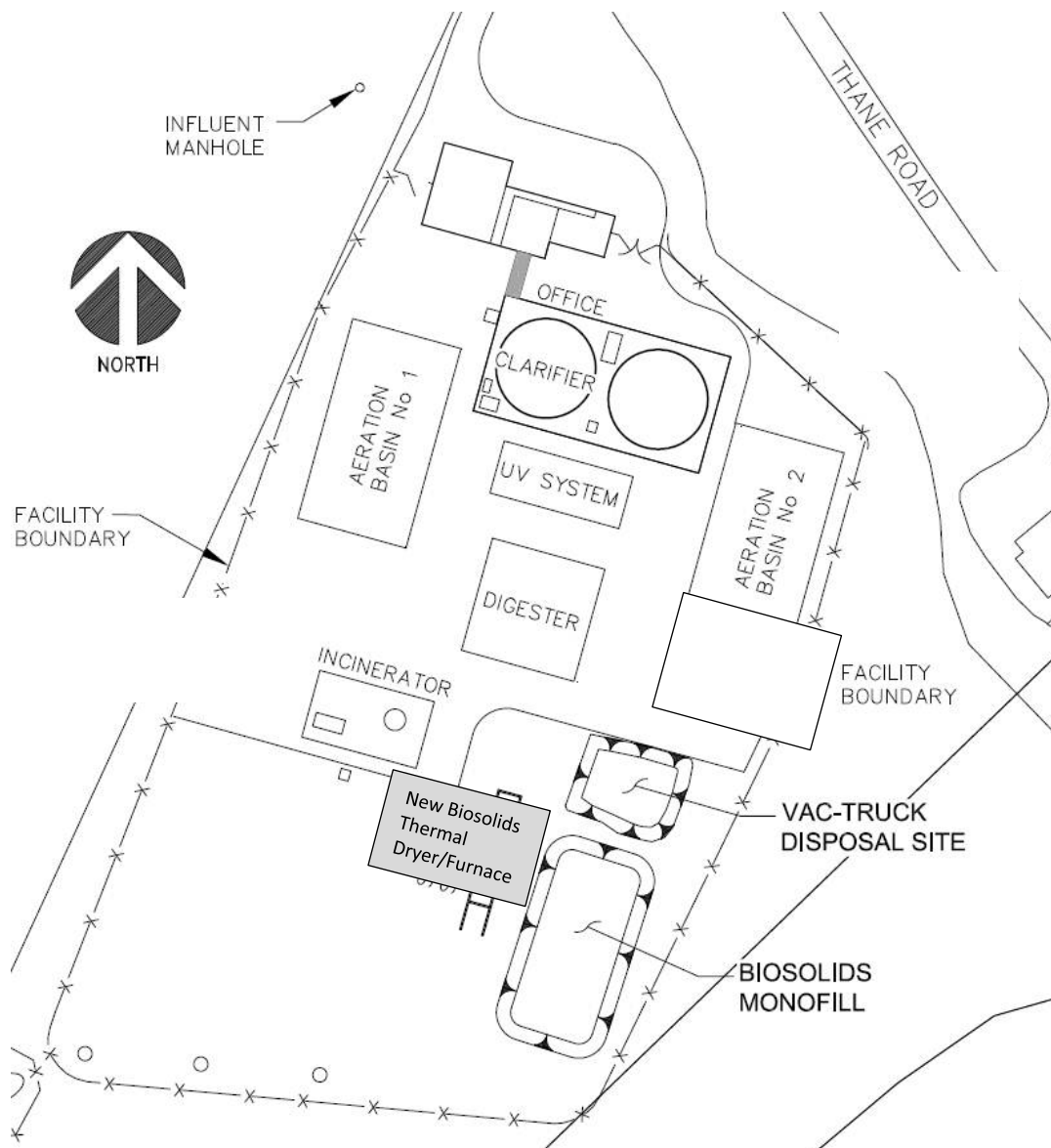

FIGURE 7
Potential Location of Thermal Dryer with Energy Recovery Furnace at the JDWWTP Site

Figure 8 indicates where a new thermal drying facility with energy-recovery furnace could be located on an aerial photo of the MWWTP site. The blue line represents the approximate property boundary of the MWWTP and the new thermal drying facility is shown at the location of the existing ABF building. The building housing existing dewatering equipment at the MWWTP is shown in the lower right of the new thermal drying facility and would remain. The existing ABF Building at the MWWTP would need to be demolished to provide space for the new thermal drying facility, to be installed in a new building in its place, as shown in Figure 8.



FIGURE 8
Potential Location of Thermal Dryer with Energy Recovery Furnace at the MWWTP Site

A preliminary general-arrangement drawing of the recommended thermal drying facility with energy-recovery furnace is shown in Figure 9, which also indicates which equipment would be provided by the drying system vendor and which equipment would be provided by other parties (designated “by others”).

3.1 Recommended Operating Strategies

This section describes operating strategies of five, similar belt-dryer installations in the USA, and provides recommendations for operating strategies at CBJ’s future biosolids drying facility.

3.1.1 Operating Strategies at Similar Facilities

The operators of Kruger’s five belt-drying facilities in the USA were contacted recently to determine how they operate their facilities, how long they have been operating, the typical weekly operating hours, the fuel source for the dryer, and the use of the dried product. Table 2 provides a summary of the findings from those belt-drying facilities.

None of the operating belt-dryer facilities reported any significant, unplanned downtime since startup. The heat-recovery furnace at Buffalo, MN, is currently out of service while ash-handling conveyors are being replaced; however, the belt dryer in Buffalo continues to operate on its normal schedule.

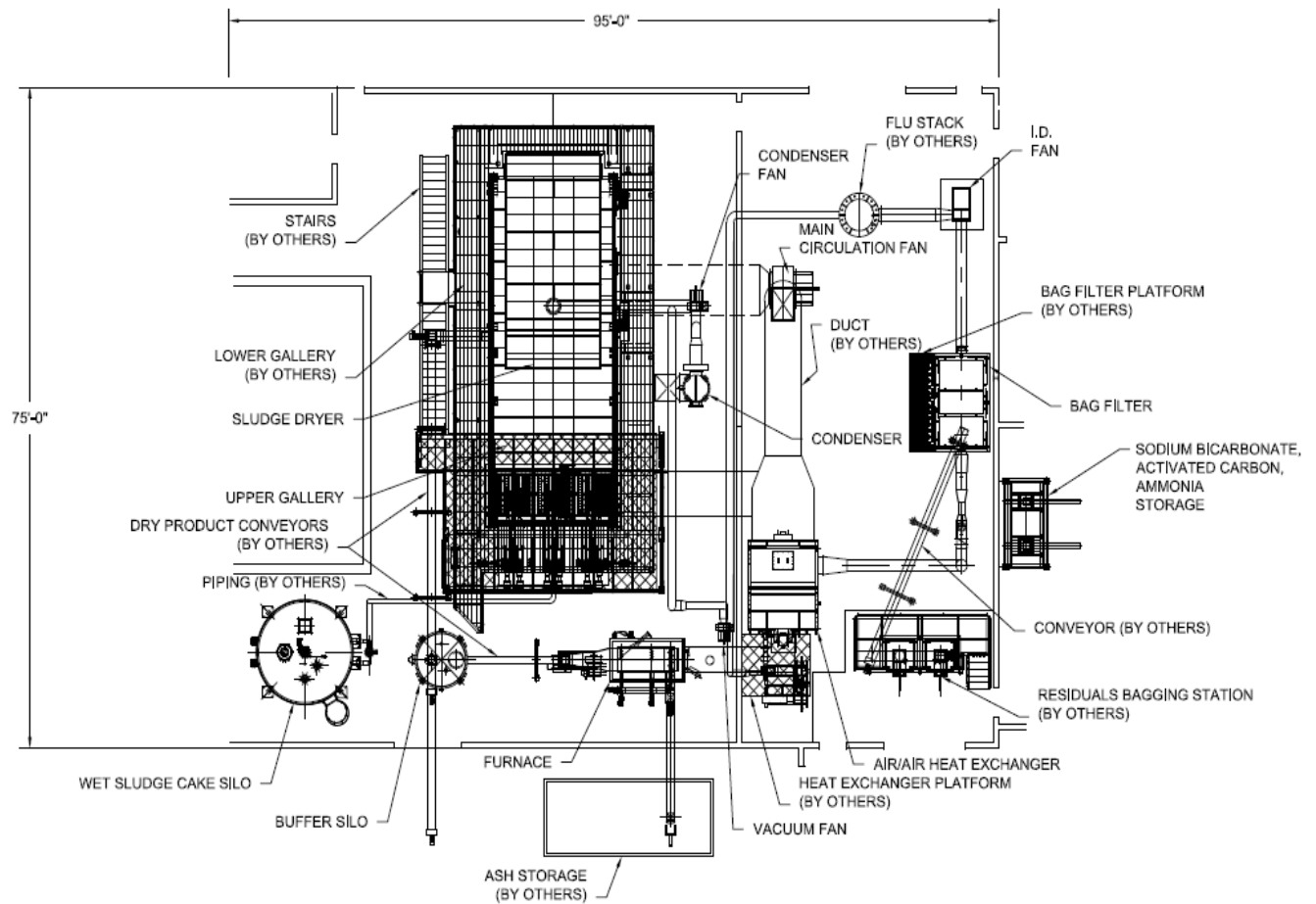

FIGURE 9
General Arrangement Drawing of Thermal Dryer with Energy Recovery Furnace

TABLE 2
Summary of Operating Belt Drying Facilities in the USA (dryers manufactured by Kruger)

Facility Location	Year of Start-up	WWTP size, MGD	Production (tons/year dried solids)	Dryer Capacity (wet pounds per hour)	Fuel Source	Normal Operating Schedule	Use of Product
Mystic Lake, MN	2006	0.64	367	1,100	Natural Gas	8 hrs/day, 5 days/week	Fuel for power plant
Buffalo, MN ¹	2008	3.0	1,512	3,300	Dried Biosolids (no backup fuel)	24 hrs/day, 7 days/week while solids are available	Ash is landfilled
LeSeuer, MN	2008	0.9	405	1,663	Natural Gas	24 hrs/day, 7 days/week while solids are available	Given to farmers
New Prague, MN	2010	2.5	1,190	6,083	Natural Gas	48-96 hrs straight, every other week	Given to farmers
Alderwood, WA	2013	6.0	1,036	3,300	Natural Gas	10 hrs/day, 5 days/week	Sold to fertilizer vendor

¹ Buffalo, MN, is the only belt drying system with a heat-recovery furnace operating in the USA to date.

The belt-drying facilities in Buffalo and New Prague, MN are oversized for their current loading rates. Coincidentally, both facilities have large volumes of pre-dewatering solids storage available. Consequently, they can store biosolids for 2-4 weeks while building up inventory for dewatering and drying operations. Once these facilities start up, they operate around-the-clock until the solids inventory is depleted. The Buffalo, MN, facility tends to operate in this manner for one period a month, and its operating period generally lasts about 10-12 days. The New Prague, MN, facility has less solids-storage capacity and so operates more frequently, typically for 48-96 hours each week.

The New Prague and Le Seuer facilities in Minnesota operate their belt dryers 24 hours per day when they have sufficient solids inventory, but their facilities are only staffed 8 hours per day. During the unstaffed 16 hours per day the belt dryers operated unattended, and the alarm functions on the belt dryers are computerized to automatically dial the telephone number of the operator on call. Both New Prague and Le Seuer reported no problems with unattended operation of their belt dryers in this manner. Buffalo, MN, keeps one operator at the WWTP all hours of the day, because it is a regulatory requirement for a WWTP of its size. Kruger reported that several of its dryers with energy-recovery furnaces in Europe operate unattended overnight, with telephonic alarm service to the operator-on-call.

3.1.2 Recommended Operating Strategies for CBJ

Based on CH2M HILL's survey of other belt dryers operating in the USA, it is recommended that CBJ plan to operate its belt dryer and heat-recovery furnace around-the-clock when it has sufficient solids inventory, similar to the mode of operation at Buffalo, MN. Both the JDWWTP and MWWTP appear to have sufficient pre-dewatering solids storage capacity, although the JDWWTP has more storage volume in its aerobic digestion basin than the MWWTP has in its settled-solids holding tank.

Based on preliminary calculations, CBJ can store at least a week's inventory of waste solids in liquid form at the JDWWTP, which can be used to operate dewatering and drying/combustion facilities around-the-clock. Biosolids storage is not available in these volumes at the MWWTP, so another aerated storage tank may need to be added to provide a week's worth of storage capacity at the MWWTP. It is also recommended that cake storage facilities be constructed at JDWWTP of sufficient volume to store one week's worth of dewatered cake solids from the MWWTP. Cake storage facilities are more costly to build and operate than liquid storage tanks, which is why the estimated capital costs for thermal drying facilities at the JDWWTP are slightly higher than at the MWWTP.

Based on CH2M HILL's survey findings regarding attended or unattended operation of belt dryers, with and without heat-recovery furnaces, it does not appear that full-time attended operation of a drying/heat recovery facility would be necessary for CBJ. Similar to operational procedures at Le Seuer and New Prague, MN, unattended operation of the dewatering and drying systems would be possible, provided that system monitoring can be done remotely via internet or telephone. Control systems for CBJ's thermal drying facilities would need to be designed with special features for remote operation. Similar remote monitoring and control systems are in operation at a number of other belt drying facilities, as noted above.

Automated storage facilities of sufficient capacity for liquid waste solids, dewatered cake solids, dried biosolids, and biosolids ash will need to be designed and provided to allow for unattended operation. Truck load-out facilities for the dewatered cake, dried biosolids, and ash will also need to be provided. The truck-loading facilities will not require remote operating capability, since truck loading activities are undertaken only when staff are onsite. Transport of dewatered biosolids will be required from one of the WWTPs to the other WWTP where the thermal drying facilities are located. It is recommended that truck hauling be done at night to minimize traffic problems and odor complaints, and decrease hauling time.

In summary, the recommended operating strategy for CBJ's new biosolids drying and energy-recovery facilities is very similar to the current operating strategies for similar drying facilities in Buffalo, Le Seuer, and New Prague, MN. For this reason it is considered important that CBJ schedule site visits to view these three existing belt drying facilities in operation.

4.1 Project Phasing and Scheduling Options

This section describes how the project would be implemented and phased under two potential scenarios:

1. Design of belt drying system and heat-recovery furnace in a single capital project using a traditional design-bid-build approach.
2. Construction of drying and heat-recovery systems in a single capital project using progressive design-build delivery approach

Based on discussion in Workshop 2, CBJ would prefer to implement Option 1 above, because it provides more time to obtain grant or loan assistance for the construction project. Option 2 would be implemented if there is a need to accelerate the project schedule by up to nine months.

The next section describes the anticipated project schedules under each of the two options listed above.

4.1.1 Anticipated Project Schedules under Two Delivery Options

The CBJ would prefer to implement the biosolids drying/heat-recovery facilities with a traditional design, bid, build delivery approach, with owner pre-purchase or pre-selection of the drying system. Early selection and purchase of the drying and heat-recovery systems would enable detailed design to proceed while the drying equipment is being designed and manufactured, which will lessen the impact of long lead times required for manufacturing and delivery of the drying and heat-recovery equipment.

Table 3 presents an anticipated, general project schedule under the Option 1 scenario above, in which the belt drying system and heat-recovery system would be designed and installed together as part of the same capital project.

It may be possible to accelerate the schedules shown in Table 3 by up to nine months by using an alternative delivery method such as progressive design-build. Under progressive design-build delivery, the project schedule would be compressed in the design and construction phases, since those phases would be delivered by the Design-Build Contractor. An anticipated project schedule under progressive design-build delivery is shown in Table 4.

TABLE 3

Anticipated Project Schedule under Option 1: Construction of Drying and Heat-Recovery Systems in a Single Capital Project

Activity	Year	2014	2015				2016				2017→		
	Quarter	4 th	1 st	2 nd	3 rd	4 th	1 st	2 nd	3 rd	4 th	1 st	2 nd	3 rd
Preliminary Engineering													
Project Funding ¹													
Design & Permitting													
Dryer/Furnace Procurement & Submittals													
Dryer/Furnace Manufacturing & Delivery ¹													
Bidding and Construction ²													
Startup ²													
Full-scale Operations													

¹ The dryer/furnace manufacturing/deliver and construction schedule are tied to project funding availability.

² Construction phase ends at substantial completion; final completion would occur after successful startup.

TABLE 4

Anticipated Project Schedule under Option 2: Construction of Drying and Heat-Recovery Systems in a Single Capital Project using Progressive Design-Build Delivery Approach

Activity	Year	2014	2015				2016				2017→	
	Quarter	4 th	1 st	2 nd	3 rd	4 th	1 st	2 nd	3 rd	4 th	1 st	2 nd
Preliminary Engineering												
Project Funding & DB Contractor Selection ¹												
Design, Permitting, and Construction ²												
Dryer/Furnace Procurement & Submittals												
Dryer/Furnace Manufacturing & Delivery ¹												
Startup ²												
Full-scale Operations												

¹The dryer/furnace manufacturing/deliver and construction schedule are tied to project funding availability.

²Construction phase ends at substantial completion; final completion would occur after successful startup.

Startup would begin earlier but take longer in Option 2 than in Option 1. It is expected that discussions and decisions regarding the desired option and delivery method for the project would occur during the preliminary engineering and project funding phases of the project, at which point one of the delivery options described above will be chosen.

4.1.2 Recommended Next Steps

In order to keep the project on schedule, CBJ is expected to endorse the Final Report and recommendations of this Phase II Biosolids Process Evaluation in the early fall of 2014. Site visits to similar biosolids belt-drying and heat-recovery facilities could also be conducted in the fall of 2014.

The scoping and negotiation of preliminary engineering and permitting phases of the project could be accomplished in October 2014, allowing preliminary engineering to get underway in November 2014. Preliminary engineering would also include the initiation of project funding and permitting activities.

If these initial project activities proceed as outlined above, then it is predicted that one of the two potential delivery options discussed above could be implemented according to the schedules shown in Tables 3 or 4.

