

MEMORANDUM

CITY & BOROUGH OF JUNEAU

155 South Seward Street, Juneau, Alaska 99801

DATE: July 18, 2012

TO: Board of Adjustment

FROM: Nicole Jones, Planner 
Community Development Department

FILE NO.: VAR2012 0013

PROPOSAL: Variance request to allow a DOT&PF road rehabilitation project along Glacier Highway between McDonalds and the Skate Park within the 330 foot setback of an eagle nest.

GENERAL INFORMATION

Applicant: State of Alaska DOT&PF

Property Owner: State of Alaska DOT&PF

Property Address: Glacier Highway/Egan Drive intersection to Mendenhall Loop/Egan Drive intersection

Legal Description: N/A

Parcel Code Number: N/A

Site Size: N/A

Zoning: Various zoning districts abut this right-of-way: D5, Light Commercial, Industrial, and General Commercial.

Utilities: None

Access: Egan Drive

Existing Land Use: Glacier Highway right-of-way

Surrounding Land Use: This project is surrounded by a variety of zoning districts including; D5, Light Commercial, Industrial, and General Commercial. The majority of the land is Commercial and Retail uses; however there is a small amount of residential.

VICINITY MAP

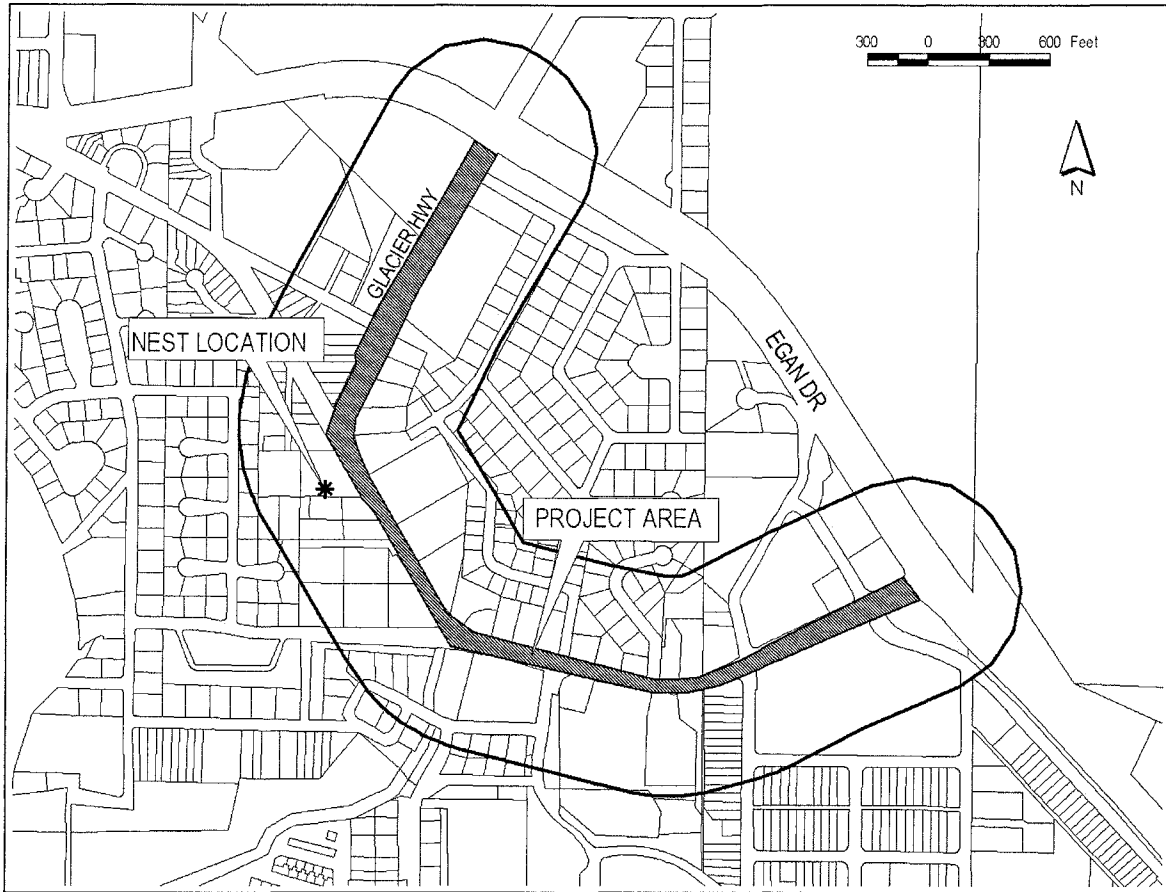

ATTACHMENTS

- Attachment A Project Description
- Attachment B E-mail from USFWS dated
- Attachment C Maps of proposed work area
- Attachment D Letter dated June 8, 2012 from USFWS to DOT&PF
- Attachment E Application Materials including project drawings
- Attachment F Public Notice

PROJECT DESCRIPTION

The applicant is proposing to rehabilitate Glacier Highway between the intersection of Egan/Glacier Highway (McDonalds) and Mendenhall Loop Road/Glacier highway (near the Skate Park), see vicinity map. The project description identifies two eagle's nests within the project area: nest # 115 and nest #126 (See Attachment A); however, nest #126 near the Mendenhall Loop Road/Glacier

Highway intersection is no longer there. US Fish and Wildlife Service (USFWS) confirmed that nest #126 is no longer there by air and then a site visit in mid June 2012 (See e-mail from USFWS Attachment B).

This variance request would allow DOT&PF to rehabilitate a section of Glacier Highway within the 330 foot buffer of an eagle nest (See Attachment C). The proposed development requires a Variance because construction, occurring on public land, would be within 330 feet of an eagle nest. The CBJ Land Use Code states the following:

49.70.310 Habitat (emphasis added)

(a) *Development in the following areas is prohibited:*

(2) Within 330 feet of an eagle nest on public land;

(3) *Within 50 feet of an eagle nest on private land, provided that there shall be no construction within 330 feet of such nest between March 1 and August 31 if it contains actively nesting eagles;*

BACKGROUND

CBJ has traditionally relied on the expertise of the local office of the USFWS to evaluate and condition, if necessary, projects within the 330 foot eagle nest buffer. In September 2009, USFWS issued a new federal rule establishing eagle permits. There are two different types of eagle permits. One permit allows for the take of eagles where the taking is associated with but not the purpose of the activity; most takes authorized under this type of permit are in the form of disturbance. The other type of permit is for the removal of an inactive eagle nest where it is necessary for public health and safety; for example, if there is a nest constructed in a human-engineered structure, or if the removal of a nest would provide a net benefit to eagles.

USFWS eagle permits are voluntary, not mandatory. However issuance of an eagle permit provides the applicant with a guarantee against federal prosecution under the Bald and Golden Eagle Protection Act if the project results in disturbance or take. It's up to the applicant to determine whether the risk of disturbance from the project is worth the time and cost of obtaining the federal permit.

CBJ has always relied on local USFWS expertise to evaluate variances to the eagle tree setback. If an applicant has obtained an eagle permit from USFWS through the new federal permit process, we will defer to the USFWS recommendation. CBJ will not, however, repeat federal permit conditions on CBJ authorizations. If the applicant has not obtained a USFWS permit, since the permit is voluntary, CBJ will seek as much information as possible from USFWS about the sensitivity of the particular nest and what modifications may be needed to ensure protection.

In this particular case, the USFWS advised DOT&PF that the pair of eagles that uses nest # 115 are, in fact, habituated. The location of the nest is close in proximity to the airport and higher traffic volumes and noise from Glacier Highway and Egan Drive. The USFWS recommended DOT&PF

not apply for an eagle permit for the work proposed in this rehabilitation project (See Attachment D).

ANALYSIS

Staff solicited comments from Community Development Building Department, General Engineering, Fire Department, CBJ Assessor's Division, CBJ Lands and Resources, CBJ Streets Department, and CBJ Parks and Recreation.

Comments were received from General Engineering, CBJ Streets Department, and the Fire Department. None of the comments received had any concern with the variance request.

Variance Requirements

Under CBJ §49.20.250 where hardship and practical difficulties result from an extraordinary situation or unique physical feature affecting only a specific parcel of property or structures lawfully existing thereon and render it difficult to carry out the provisions of Title 49, the Board of Adjustment may grant a Variance in harmony with the general purpose and intent of Title 49. A Variance may vary any requirement or regulation of Title 49 concerning dimensional and other design standards, but not those concerning the use of land or structures, housing density, lot coverage, or those establishing construction standards. A Variance may be granted after the prescribed hearing and after the Board of Adjustment has determined:

- 1. That the relaxation applied for or a lesser relaxation specified by the Board of Adjustment would give substantial relief to the owner of the property involved and be more consistent with justice to other property owners.***

The relaxation applied for would give substantial relief to the property owner by allowing maintenance of Glacier Highway. A lesser relaxation is not practical because the maintenance must take place within 330 feet of an existing eagle nests, and failing to maintain the roadway would result in a public safety hazard. The Variances would be consistent with justice to other property owners along the highway by allowing required maintenance to provide safe access to their property.

Yes. Staff finds that criterion 1 is met.

- 2. That relief can be granted in such a fashion that the intent of this title will be observed and the public safety and welfare be preserved.***

The intent of Title 49 is established in Section 49.05.100 Purpose and Intent. Those sections, which are applicable to the requested variance, are as follows:

- 1) To achieve the goals and objectives and implement the policies of the Juneau Comprehensive Plan and the coastal management program;

- 2) To ensure that future growth and development in the city and borough is in accord with the values of its residents;
- 3) To identify and secure, for present and future residences, the beneficial impacts of growth while minimizing the negative impacts;
- 4) To ensure that future growth is of the appropriate type, design, and location, and is served by a proper range of public services and facilities such as water, sewage, and electrical distribution systems, transportation, schools, parks and other public requirements, and in general to promote public health, safety and general welfare;
- 5) To provide adequate open space for light and air; and
- 6) To recognize the economic value of land and encourage its proper and beneficial use.

A grant of the variance would allow rehabilitation of Glacier Highway within 330 feet of an eagle nest. Additionally, USFWS has issued a letter stating that an eagle permit is not necessary because “the project poses low risk to nesting eagles” (See letter from USFWS Attachment D). The Variance is therefore in accordance with intent numbers 2, 3, 4, and 6.

Yes. Staff finds that criterion 2 is met.

3. *That the authorization of the Variance will not injure nearby property.*

Construction within the eagle tree setback would not injure nearby property. All work would be within the right-of-way.

Yes. Staff finds that criterion 3 is met.

4. *That the Variance does not authorize uses not allowed in the district involved.*

Road construction is allowed in all zoning districts; therefore, the Variance does not authorize uses not allowed in the district involved.

Yes. Staff finds that criterion 4 is met.

5. *That compliance with the existing standards would:*

(A) *Unreasonably prevent the owner from using the property for a permissible principal use;*

Compliance with the standard would unreasonably prevent the owner, DOT&PF, from maintaining this portion of Glacier Highway. However highway maintenance is not technically considered a permissible principal use in any zoning district.

No. Staff finds that sub-criterion 5A is not met.

(B) *Unreasonably prevent the owner from using the property in a manner which is consistent as to scale, amenities, appearance or features, with existing development in the neighborhood of the subject property;*

Compliance with the standard would unreasonably prevent the owner, DOT&PF, from maintaining this portion of Glacier Highway. Allowing the highway to fall into disrepair would create a public safety hazard and be detrimental to the amenities, appearance, and features of existing development in the neighborhood of the subject property. Comparing the Glacier Highway right-of-way to other residential properties in the neighborhood adjacent to the right-of-way is not a relevant comparison.

Yes. Staff finds that sub-criterion 5B is met.

(C) *Be unnecessarily burdensome because unique physical features of the property render compliance with the standards unreasonably expensive;*

There are no unique physical features along Glacier Highway. The roadway is mostly flat with only the occasional gradual hill and curves in the road.

No. Staff finds that sub-criterion 5C is not met.

or

(D) *Because of preexisting nonconforming conditions on the subject parcel the grant of the Variance would not result in a net decrease in overall compliance with the Land Use Code, CBJ Title 49, or the building code, CBJ Title 19, or both.*

There are no pre-existing non-conforming conditions within the Glacier Highway right-of-way.

N/A. Staff finds that sub-criterion 5D is not applicable.

Yes. Staff finds that criterion 5 is met because sub-criterion 5B is met.

6. *That a grant of the Variance would result in more benefits than detriments to the neighborhood.*

A grant of the Variance would allow this stretch of Glacier Highway from the Egan/Glacier Highway intersection to the Mendenhall Loop Road/Glacier Highway intersection to be maintained according to current road safety standards, which would provide a significant benefit to the neighborhood. The USFWS is not concerned that the proposed rehabilitation would impact the eagles at this location. Therefore the Variance would result in more benefits than detriments to the neighborhood.

Yes. Staff finds that criterion 6 is met.

FINDINGS

1. *Is the application for the requested Variance complete?*

Yes. We find the application contains the information necessary to conduct full review of the proposed operations. The application submittal by the applicant, including the appropriate fees, substantially conforms to the requirements of CBJ Chapter 49.15.

Per CBJ §49.70.900 (b)(3), General Provisions, the Director makes the following Juneau Coastal Management Program consistency determination:

2. *Will the proposed development comply with the Juneau Coastal Management Programs?*

N/A. This variance request complies with the Juneau Coastal Management Program.

3. *Does the variance as requested, meet the criteria of Section 49.20.250, Grounds for Variances?*

Yes. Based on the analysis above, staff finds that the proposal does meet the criteria of CBJ 49.0.250, Grounds for Variances. Specifically, the Variance meets criteria 1, 2, 3, 4, 5B, and 6.

RECOMMENDATION

Staff recommends that the Board of Adjustment adopt the Director's analysis and findings and approve the requested Variance, VAR2012 0013. The Variance permit would allow for the rehabilitation of Glacier Highway within 330 feet of an eagle nest.

STATE OF ALASKA

DEPARTMENT OF TRANSPORTATION AND PUBLIC FACILITIES

*Southeast Region Design & Engineering Services
Preliminary Design & Environmental Section*

SEAN PARNELL, GOVERNOR

6860 Glacier Highway
P.O. Box 112506
Juneau, Alaska 99811-2506
Phone: 907-465-4234
1-800-575-4540
Fax: 907-465-3506
TTY: 1-800-770-8255

Juneau-Glacier Highway Pavement Rehabilitation Project, #67432

Project Location and Description

Project Location

The proposed project is located on Glacier Highway and is approximately 5,100 feet in length. The beginning of the project (BOP) is at the intersection of Egan Drive and Glacier Highway. The project follows the loop to the end of the project at the Mendenhall Loop Road/Glacier Highway intersection (EOP). This segment is located in Sections 30 and 31, T40S, R66E, Copper River Meridian, on the Juneau B-2 USGS Quadrangle Map.

Project Description

Glacier Highway has experienced significant wear and is near the end of its useful life. The proposed project would rehabilitate the road with a new layer of asphalt concrete pavement. Additional improvements would include in-kind repairs to curb cuts and curb ramps to meet the Americans with Disabilities Act (ADA) standards where needed. All work would occur within the existing right-of-way.

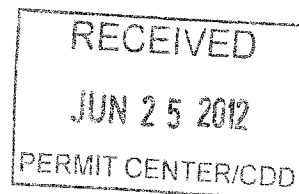

"Providing for the safe movement of people and goods and the delivery of services"

ATTACHMENT A

Nicole Jones

From: Steve_B_Lewis@fws.gov
Sent: Monday, July 16, 2012 3:12 PM
To: Nicole Jones
Subject: RE: Nest #126

Actually, Scott and I looked for it from the air on 4/17/2012 and I followed up on the ground on 6/18/12.

Thanks,

Steve

~~~~~  
 Stephen B. Lewis  
 Migratory Bird Management - Raptors  
 U. S. Fish and Wildlife Service  
 Juneau, Alaska  
 voice: (907) 780-1163  
 fax: (907) 586-7099  
 email: steve\_b\_lewis@fws.gov  
 ~~~~~

* Nicole Jones <Nicole_Jones@ci.juneau.ak.us>

Nicole Jones
 <Nicole_Jones@ci.juneau.ak.us>

07/16/2012 02:26 PM

To"Steve_B_Lewis@fws.gov"
 <Steve_B_Lewis@fws.gov>
 cc
 SubjectRE: Nest #126

Did you confirm this on 6/18/2012?

Nicole Jones, Planner I, CFM
 CBJ Community Development Department
 155 S. Seward St.
 Juneau, AK 99801
 Ph: 907.586.0218
 Fax: 907.586.3365

From: Steve_B_Lewis@fws.gov [mailto:Steve_B_Lewis@fws.gov]
Sent: Monday, July 16, 2012 2:24 PM
To: Nicole Jones
Subject: Re: Nest #126

Nicole,

The eagle nest located on the corner of Egan and Mendenhall Loop Road (#11722.126) is no longer there. I confirmed this on 7/18/2012.

Steve Lewis

~~~~~  
 Stephen B. Lewis  
 Migratory Bird Management - Raptors  
 U. S. Fish and Wildlife Service

**ATTACHMENT B**

7/16/2012

Juneau, Alaska  
voice: (907) 780-1163  
fax: (907) 586-7099  
email: steve\_b\_lewis@fws.gov

---

☞ Nicole Jones <Nicole\_Jones@ci.juneau.ak.us>

**Nicole Jones**  
<Nicole\_Jones@ci.juneau.ak.us>

"steve\_b\_lewis@fws.gov"  
To<steve\_b\_lewis@fws.gov>

07/11/2012 09:21 AM

cc  
Nest #126  
Subject

Hi Steve,

We discussed on the phone that the eagle nest #126 on the corner of Egan and Mendenhall Loop Road (near Del Rae Condos) is no longer there. Can you confirm this in writing, via e-mail?  
Thanks!

Nicole Jones, Planner I, CFM  
CBJ Community Development Department  
155 S. Seward St.  
Juneau, AK 99801  
Ph: 907.586.0218  
Fax: 907.586.3365

7/16/2012

RECEIVED  
JUN 25 2012  
PERMIT CENTER/CDD

Q:\JNU\67432\DR\ICORP\67432\_03-04.DWG

GRANTHAM, RICK L (DOT)

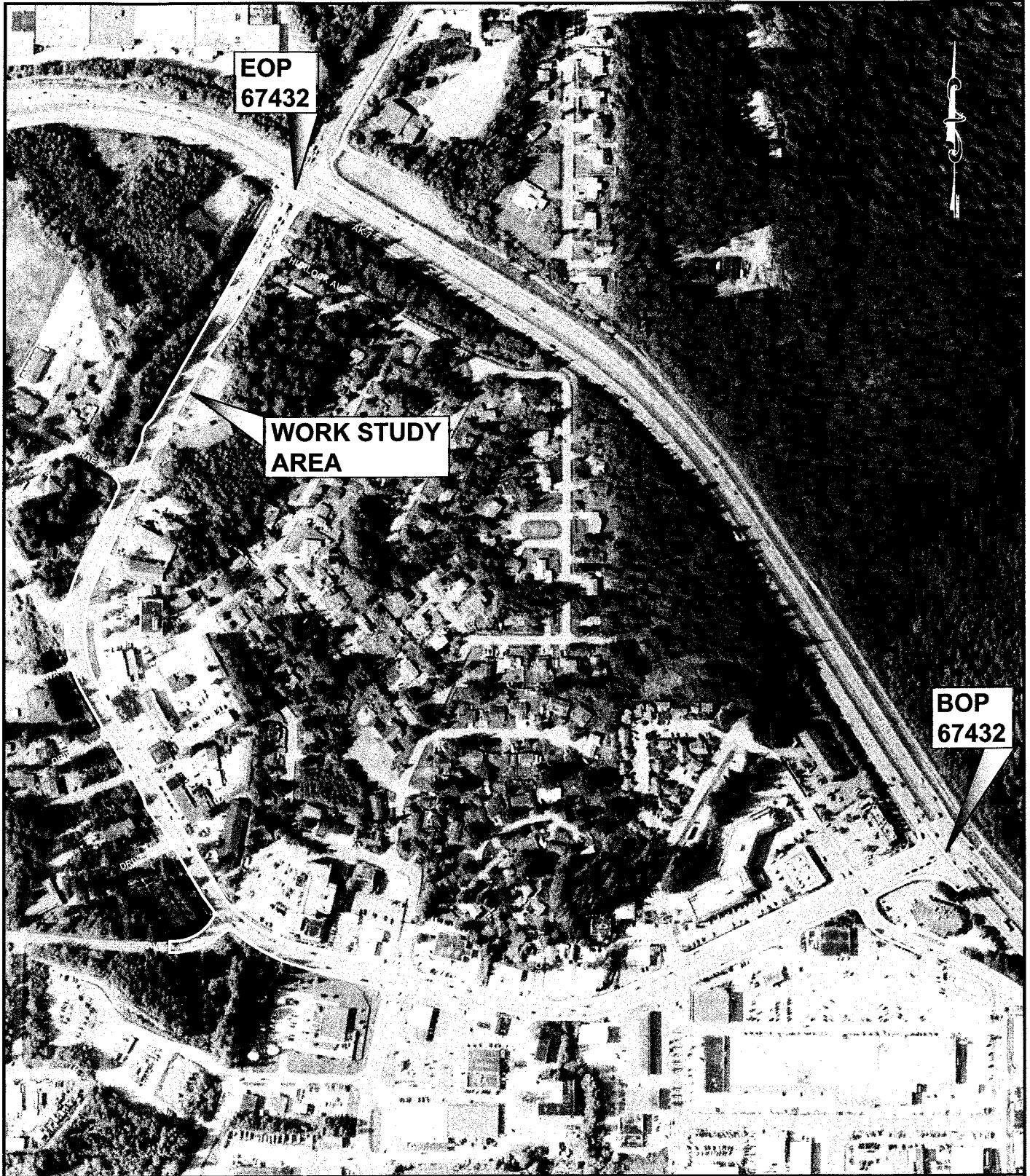

WATER BODIES:  
GASTINEAU CHANNEL

**WORK STUDY AREA  
GLACIER HWY SEGMENT**

APPLICATION BY:  
ALASKA STATE DEPT. OF TRANSPORTATION  
AND PUBLIC FACILITIES  
SOUTHEAST REGION

JNU AREA WIDE ROAD  
PAVEMENT REHABILITATION  
PROJECT #67432

AT: JUNEAU, ALASKA  
LOCATED IN: SECTION 5, T42S, R68E  
COPPER RIVER MERIDIAN  
JUNEAU B-1  
QUADRANGLE MAP

DATE: MAY 7, 2012 SHEET 3 OF 6

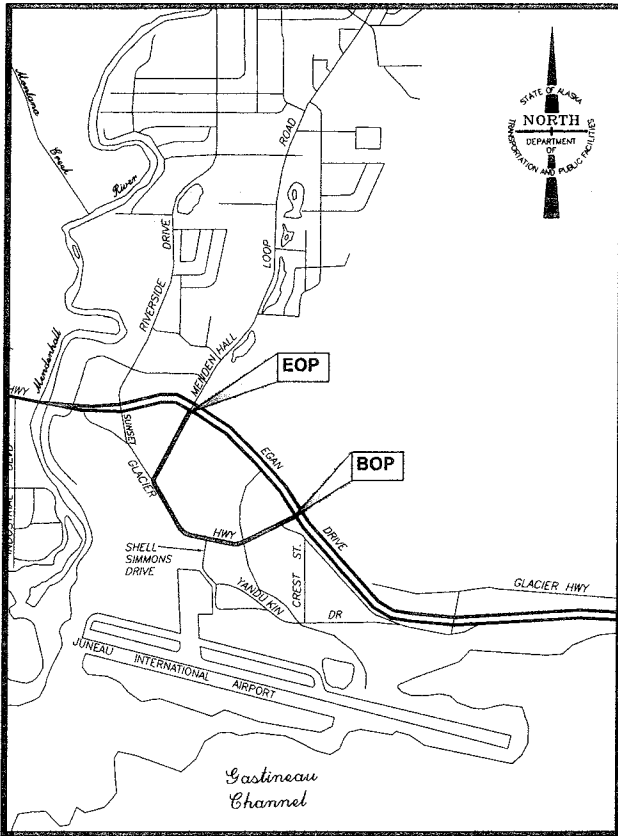
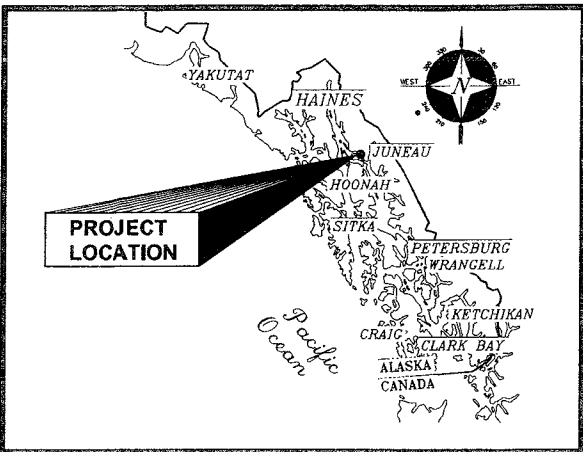
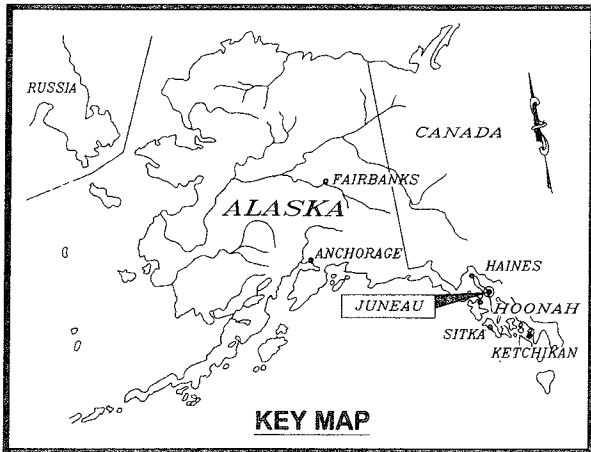

This space left blank intentionally

RECEIVED

JUN 25 2012

PERMIT CENTER/CDD

**GLACIER HIGHWAY SEGMENT**

**VICINITY MAP**

**WATER BODIES:**  
GASTINEAU CHANNEL

**KEY AND REGIONAL MAPS**

APPLICATION BY:  
ALASKA STATE DEPT. OF TRANSPORTATION  
AND PUBLIC FACILITIES  
SOUTHEAST REGION

JNU AREA WIDE ROAD  
PAVEMENT REHABILITATION  
PROJECT #67432

AT: JUNEAU, ALASKA  
LOCATED IN: SECTION 5, T42S, R68E  
COPPER RIVER MERIDIAN  
JUNEAU B-1  
QUADRANGLE MAP

DATE: MAY 7, 2012 SHEET 1 OF 6

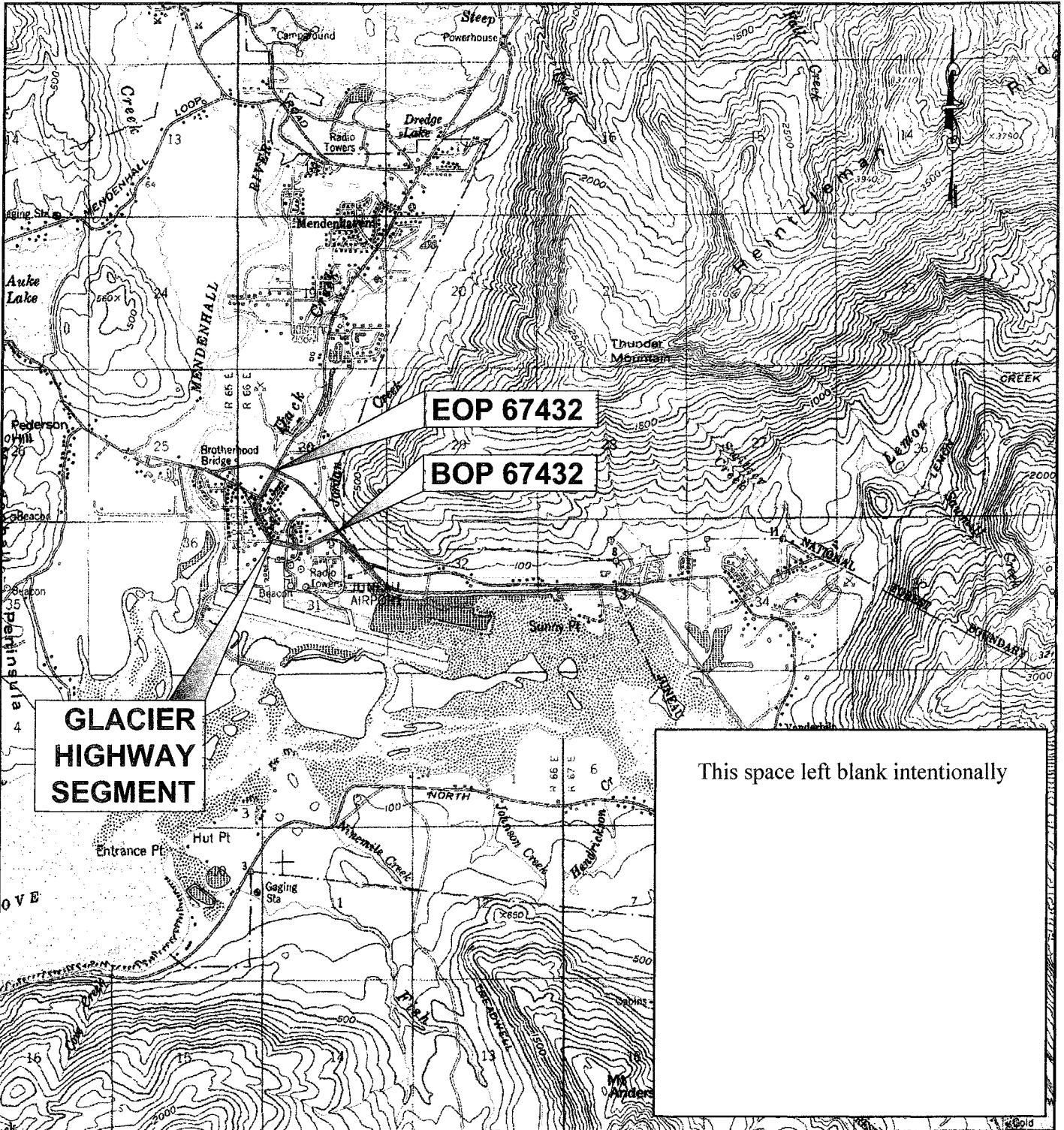

This space left blank intentionally

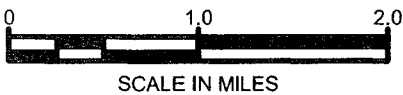

WATER BODIES:  
GASTINEAU CHANNEL

**PROJECT LOCATION  
MAP**

APPLICATION BY:  
ALASKA STATE DEPT. OF TRANSPORTATION  
AND PUBLIC FACILITIES  
SOUTHEAST REGION

JNU AREA WIDE ROAD  
PAVEMENT REHABILITATION  
PROJECT #67432

AT: JUNEAU, ALASKA  
LOCATED IN: SECTION:5, T42S, R68E  
COPPER RIVER MERIDIAN  
JUNEAU B-1  
QUADRANGLE MAP

DATE: MAY 7, 2012 SHEET 2 OF 6



RECEIVED  
JUN 28 2012  
PERMIT CENTER/CDD

United States Department of the Interior  
FISH AND WILDLIFE SERVICE  
Juneau Fish & Wildlife Field Office  
3000 Vintage Blvd., Suite 201  
Juneau, Alaska 99801-7100  
(907) 780-1160



06/08/2012

Chris Schelb  
Dept. of Transportation and Public Facilities  
6860 Glacier Highway  
PO Box 112506  
Juneau, AK 99811-2506

RE: Mendenhall Loop Road Repaving and Curb Repair

Dear Mr. Schelb,

This responds to your request for assistance in determining if the above referenced project will have adverse impacts on eagle nests in the project area. After review of the Mendenhall Loop Road Repaving and Curb Repair documents we find there will be no adverse impacts from the project to nesting eagles and do not recommend applying for an eagle disturbance permit.

#### Description of the Proposed Actions

The Department of Transportation proposes to repave and conduct curb repair work from the intersection of Egan Drive (across from McDonalds), continuing around Mendenhall Loop Road and terminating at Egan Drive.

#### Bald Eagles

According to our Eagle Nest Database, there is one eagle nest in the project area (see Fig 1). Although the project is within the 330' buffer recommended by the National Bald Eagle Management Guidelines, the eagle pair has demonstrated tolerance to human activity. Tolerance has been demonstrated by the pair building a nest within 100' of Mendenhall Loop Road, the proximity of the nest to a small business, and continuous noise from the airport. We do not recommend applying for an eagle disturbance permit because the project poses low risk to nesting eagles.

Please contact this office if any previously unknown eagle nests are discovered within 330' of the project areas for documentation in the Alaska Bald Eagle Nest Database or for further guidance on eagle disturbance permits.

**ATTACHMENT D**

We appreciate your efforts to address our concerns. If you have any questions about the issues discussed above, please call Scott Frickey at (907)780-1184.

Sincerely,

*for*   
Bill Hanson  
Field Supervisor

Fig 1

Mendenhall Loop Rd.

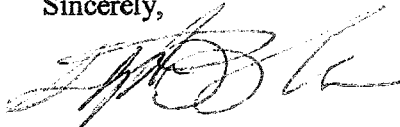
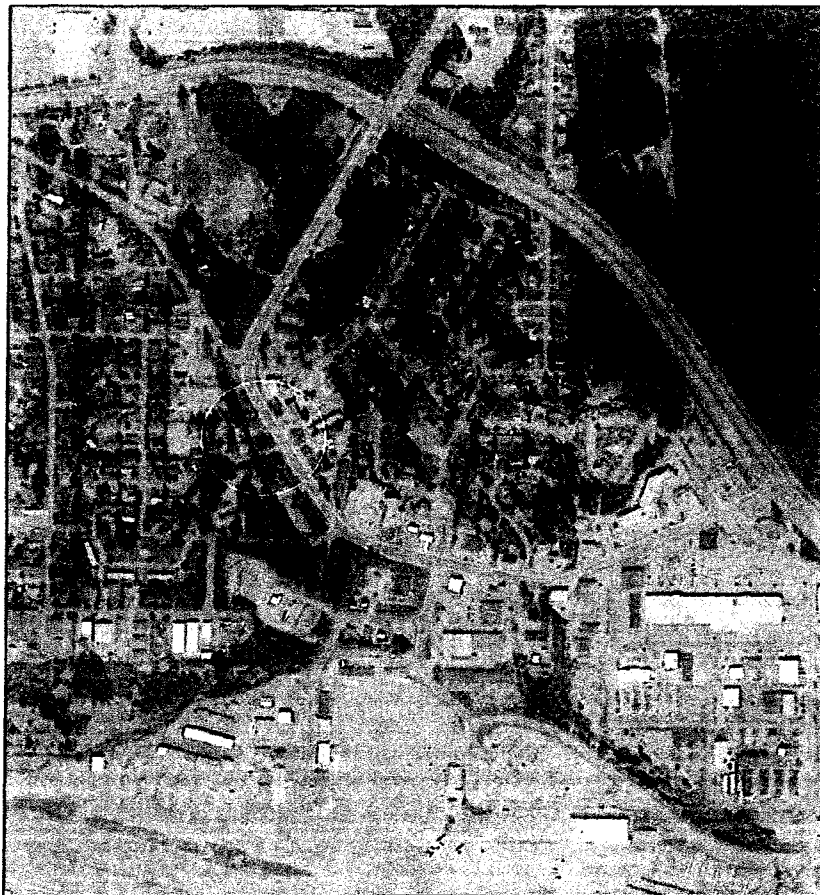

**Legend**

- ◆ Eagle Nest Locations
- 330' Recommended Buffer

0 250 500 1,000 Feet

# DEVELOPMENT PERMIT APPLICATION

(APPLICANT - PLEASE FILL IN THE PROJECT/APPLICANT INFORMATION)

|                                          |                                   |                |
|------------------------------------------|-----------------------------------|----------------|
| Project Number                           | <b>CITY and BOROUGH of JUNEAU</b> | Date Received: |
| Project Name (City Staff to assign name) |                                   |                |

| PROJECT / APPLICANT INFORMATION                                                                                                                                                                                                                                                                                                                                                                                                                                                                                                                                                                                                                                                                         | Project Description <b>Glacier Highway Pavement Rehabilitation, Glacier/Egan Dr intersection to Mendenhall Loop/Egan Dr intersection.</b>                                                                                                                                                                                                                                                                                                          |                                                                               |                                                                                                                                                                                                                                                                                                                                                                                                                                               |                                |                  |                  |               |  |                 |  |          |  |               |  |             |  |       |
|---------------------------------------------------------------------------------------------------------------------------------------------------------------------------------------------------------------------------------------------------------------------------------------------------------------------------------------------------------------------------------------------------------------------------------------------------------------------------------------------------------------------------------------------------------------------------------------------------------------------------------------------------------------------------------------------------------|----------------------------------------------------------------------------------------------------------------------------------------------------------------------------------------------------------------------------------------------------------------------------------------------------------------------------------------------------------------------------------------------------------------------------------------------------|-------------------------------------------------------------------------------|-----------------------------------------------------------------------------------------------------------------------------------------------------------------------------------------------------------------------------------------------------------------------------------------------------------------------------------------------------------------------------------------------------------------------------------------------|--------------------------------|------------------|------------------|---------------|--|-----------------|--|----------|--|---------------|--|-------------|--|-------|
|                                                                                                                                                                                                                                                                                                                                                                                                                                                                                                                                                                                                                                                                                                         | <b>PROPERTY LOCATION</b>                                                                                                                                                                                                                                                                                                                                                                                                                           |                                                                               |                                                                                                                                                                                                                                                                                                                                                                                                                                               |                                |                  |                  |               |  |                 |  |          |  |               |  |             |  |       |
|                                                                                                                                                                                                                                                                                                                                                                                                                                                                                                                                                                                                                                                                                                         | Street Address <b>Glacier Highway Channel Drive</b>                                                                                                                                                                                                                                                                                                                                                                                                |                                                                               | City / Zip <b>99801</b>                                                                                                                                                                                                                                                                                                                                                                                                                       |                                |                  |                  |               |  |                 |  |          |  |               |  |             |  |       |
|                                                                                                                                                                                                                                                                                                                                                                                                                                                                                                                                                                                                                                                                                                         | Subdivision (if known)                                                                                                                                                                                                                                                                                                                                                                                                                             | Survey (if known)                                                             | Block / Tract (if known)                                                                                                                                                                                                                                                                                                                                                                                                                      | Lot (if known)                 |                  |                  |               |  |                 |  |          |  |               |  |             |  |       |
|                                                                                                                                                                                                                                                                                                                                                                                                                                                                                                                                                                                                                                                                                                         | Assessor's Parcel Number (if known)                                                                                                                                                                                                                                                                                                                                                                                                                |                                                                               |                                                                                                                                                                                                                                                                                                                                                                                                                                               |                                |                  |                  |               |  |                 |  |          |  |               |  |             |  |       |
|                                                                                                                                                                                                                                                                                                                                                                                                                                                                                                                                                                                                                                                                                                         | <b>LANDOWNER / LESSEE</b>                                                                                                                                                                                                                                                                                                                                                                                                                          |                                                                               |                                                                                                                                                                                                                                                                                                                                                                                                                                               |                                |                  |                  |               |  |                 |  |          |  |               |  |             |  |       |
|                                                                                                                                                                                                                                                                                                                                                                                                                                                                                                                                                                                                                                                                                                         | Property Owner's Name <b>St of AK, DOT&amp;PF</b> <input type="checkbox"/> Contact by E-Mail:                                                                                                                                                                                                                                                                                                                                                      |                                                                               | Contact Person                                                                                                                                                                                                                                                                                                                                                                                                                                | Work Phone No. <b>465-1763</b> |                  |                  |               |  |                 |  |          |  |               |  |             |  |       |
|                                                                                                                                                                                                                                                                                                                                                                                                                                                                                                                                                                                                                                                                                                         | Mailing Address <b>PO Box 112506 Juneau AK 99811-2506</b>                                                                                                                                                                                                                                                                                                                                                                                          |                                                                               | Home Phone No.                                                                                                                                                                                                                                                                                                                                                                                                                                | FAX No.                        |                  |                  |               |  |                 |  |          |  |               |  |             |  |       |
|                                                                                                                                                                                                                                                                                                                                                                                                                                                                                                                                                                                                                                                                                                         | <b>LANDOWNER/LESSEE CONSENT</b> (Required for Planning permits not needed on Building/Engineer permits)                                                                                                                                                                                                                                                                                                                                            |                                                                               | <b>INITIAL ALL THAT MAY APPLY</b>                                                                                                                                                                                                                                                                                                                                                                                                             |                                |                  |                  |               |  |                 |  |          |  |               |  |             |  |       |
|                                                                                                                                                                                                                                                                                                                                                                                                                                                                                                                                                                                                                                                                                                         | <p>I am (we are) the owner(s) or Lessee of the property subject to this application and I (we) consent as follows:</p> <p>A. This application for a land use or activity review for development on my (our) property is made with my complete understanding and permission.</p> <p>B. I (we) grant permission for officials and employees of the City and Borough of Juneau to inspect my property as needed for purposes of this application.</p> |                                                                               | <table border="1" style="width: 100%; border-collapse: collapse;"> <tr> <th style="width: 50%;">APPLICATION TYPE</th> <th style="width: 50%;">OWNER'S INITIALS</th> </tr> <tr> <td>ALLOWABLE USE</td> <td></td> </tr> <tr> <td>CONDITIONAL USE</td> <td></td> </tr> <tr> <td>VARIANCE</td> <td></td> </tr> <tr> <td>DESIGN REVIEW</td> <td></td> </tr> <tr> <td>SUBDIVISION</td> <td></td> </tr> <tr> <td>OTHER</td> <td></td> </tr> </table> |                                | APPLICATION TYPE | OWNER'S INITIALS | ALLOWABLE USE |  | CONDITIONAL USE |  | VARIANCE |  | DESIGN REVIEW |  | SUBDIVISION |  | OTHER |
| APPLICATION TYPE                                                                                                                                                                                                                                                                                                                                                                                                                                                                                                                                                                                                                                                                                        | OWNER'S INITIALS                                                                                                                                                                                                                                                                                                                                                                                                                                   |                                                                               |                                                                                                                                                                                                                                                                                                                                                                                                                                               |                                |                  |                  |               |  |                 |  |          |  |               |  |             |  |       |
| ALLOWABLE USE                                                                                                                                                                                                                                                                                                                                                                                                                                                                                                                                                                                                                                                                                           |                                                                                                                                                                                                                                                                                                                                                                                                                                                    |                                                                               |                                                                                                                                                                                                                                                                                                                                                                                                                                               |                                |                  |                  |               |  |                 |  |          |  |               |  |             |  |       |
| CONDITIONAL USE                                                                                                                                                                                                                                                                                                                                                                                                                                                                                                                                                                                                                                                                                         |                                                                                                                                                                                                                                                                                                                                                                                                                                                    |                                                                               |                                                                                                                                                                                                                                                                                                                                                                                                                                               |                                |                  |                  |               |  |                 |  |          |  |               |  |             |  |       |
| VARIANCE                                                                                                                                                                                                                                                                                                                                                                                                                                                                                                                                                                                                                                                                                                |                                                                                                                                                                                                                                                                                                                                                                                                                                                    |                                                                               |                                                                                                                                                                                                                                                                                                                                                                                                                                               |                                |                  |                  |               |  |                 |  |          |  |               |  |             |  |       |
| DESIGN REVIEW                                                                                                                                                                                                                                                                                                                                                                                                                                                                                                                                                                                                                                                                                           |                                                                                                                                                                                                                                                                                                                                                                                                                                                    |                                                                               |                                                                                                                                                                                                                                                                                                                                                                                                                                               |                                |                  |                  |               |  |                 |  |          |  |               |  |             |  |       |
| SUBDIVISION                                                                                                                                                                                                                                                                                                                                                                                                                                                                                                                                                                                                                                                                                             |                                                                                                                                                                                                                                                                                                                                                                                                                                                    |                                                                               |                                                                                                                                                                                                                                                                                                                                                                                                                                               |                                |                  |                  |               |  |                 |  |          |  |               |  |             |  |       |
| OTHER                                                                                                                                                                                                                                                                                                                                                                                                                                                                                                                                                                                                                                                                                                   |                                                                                                                                                                                                                                                                                                                                                                                                                                                    |                                                                               |                                                                                                                                                                                                                                                                                                                                                                                                                                               |                                |                  |                  |               |  |                 |  |          |  |               |  |             |  |       |
| <p><input checked="" type="checkbox"/> <b>Landowner/Lessee Signature</b> <u>[Signature]</u> <input type="checkbox"/> <b>Date</b> <u>6/22/12</u></p> <p><input checked="" type="checkbox"/> <b>Landowner/Lessee Signature</b> <u>[Signature]</u> <input type="checkbox"/> <b>Date</b> <u>6/22/12</u></p> <p>NOTICE: The City and Borough of Juneau staff may need access to the subject property during regular business hours and will attempt to contact the landowner in addition to the formal consent given above. Further, members of the Planning Commission and/or the Design Review Board may visit the property and may do so during the weekend before the scheduled public hearing date.</p> |                                                                                                                                                                                                                                                                                                                                                                                                                                                    |                                                                               |                                                                                                                                                                                                                                                                                                                                                                                                                                               |                                |                  |                  |               |  |                 |  |          |  |               |  |             |  |       |
| <b>APPLICANT</b> (If same as OWNER, write "SAME" and sign and date at X below)                                                                                                                                                                                                                                                                                                                                                                                                                                                                                                                                                                                                                          |                                                                                                                                                                                                                                                                                                                                                                                                                                                    |                                                                               |                                                                                                                                                                                                                                                                                                                                                                                                                                               |                                |                  |                  |               |  |                 |  |          |  |               |  |             |  |       |
| Applicant's Name <b>St of AK, DOT&amp;PF</b> <input type="checkbox"/> Contact by E-Mail:                                                                                                                                                                                                                                                                                                                                                                                                                                                                                                                                                                                                                |                                                                                                                                                                                                                                                                                                                                                                                                                                                    | Contact Person                                                                | Work Phone No. <b>465-1763</b>                                                                                                                                                                                                                                                                                                                                                                                                                |                                |                  |                  |               |  |                 |  |          |  |               |  |             |  |       |
| Mailing Address <b>PO Box 112506 Juneau, AK 99811-2506</b>                                                                                                                                                                                                                                                                                                                                                                                                                                                                                                                                                                                                                                              |                                                                                                                                                                                                                                                                                                                                                                                                                                                    | Home Phone No.                                                                | FAX No.                                                                                                                                                                                                                                                                                                                                                                                                                                       |                                |                  |                  |               |  |                 |  |          |  |               |  |             |  |       |
| <input checked="" type="checkbox"/> <b>Applicant's Signature</b> <u>[Signature]</u>                                                                                                                                                                                                                                                                                                                                                                                                                                                                                                                                                                                                                     |                                                                                                                                                                                                                                                                                                                                                                                                                                                    | <input checked="" type="checkbox"/> <b>Date of Application</b> <u>6/22/12</u> |                                                                                                                                                                                                                                                                                                                                                                                                                                               |                                |                  |                  |               |  |                 |  |          |  |               |  |             |  |       |

(OFFICE USE ONLY BELOW THIS LINE)

|                 |                 |                                                                                        |       |                   |                  |                              |                                      |                        |                 |
|-----------------|-----------------|----------------------------------------------------------------------------------------|-------|-------------------|------------------|------------------------------|--------------------------------------|------------------------|-----------------|
| STAFF APPROVALS | C               | PERMIT TYPE                                                                            | SIGN  | DATE RECEIVED     | APPLICATION NO.  | C                            | PERMIT TYPE                          | DATE RECEIVED          | APPLICATION NO. |
|                 | K               | ALLOWABLE USE APPROVAL                                                                 |       |                   |                  | K                            | WATER PERMIT                         |                        |                 |
|                 |                 | CONDITIONAL USE APPROVAL                                                               |       |                   |                  |                              | SEWER PERMIT                         |                        |                 |
|                 |                 | VARIANCE                                                                               |       | <u>6/25/12</u>    | <u>00512-613</u> |                              | GRADING PERMIT                       |                        |                 |
|                 |                 | DESIGN REVIEW APPROVAL                                                                 | MINOR |                   |                  |                              | DRIVEWAY PERMIT                      |                        |                 |
|                 |                 |                                                                                        | MAJOR |                   |                  |                              |                                      |                        |                 |
|                 |                 | SUBDIVISION                                                                            | MINOR |                   |                  |                              | RIGHT-OF-WAY PERMIT                  |                        |                 |
|                 |                 |                                                                                        | MAJOR |                   |                  |                              |                                      |                        |                 |
|                 |                 |                                                                                        | PUD   |                   |                  |                              |                                      |                        |                 |
|                 |                 | STREET VACATION                                                                        |       |                   |                  |                              | PUB. FAC. TRANSMISS. & EXCAV. PERMIT |                        |                 |
|                 | SIGN APPROVAL   | LOCATED IN HISTORIC DISTRICT? <input type="checkbox"/> YES <input type="checkbox"/> NO |       |                   |                  | OTHER - (Describe)           |                                      |                        |                 |
|                 | BUILDING PERMIT |                                                                                        |       |                   |                  | Permit Intake Initials _____ |                                      |                        |                 |
| Zone _____      |                 | Total Lot Area _____                                                                   |       | Required Setbacks |                  |                              |                                      |                        |                 |
|                 |                 |                                                                                        |       | Front _____       |                  | Back _____                   |                                      | Side _____ Other _____ |                 |
| COMMENTS:       |                 |                                                                                        |       |                   |                  |                              |                                      |                        |                 |
|                 |                 |                                                                                        |       |                   |                  |                              |                                      |                        |                 |
|                 |                 |                                                                                        |       |                   |                  |                              |                                      |                        |                 |
|                 |                 |                                                                                        |       |                   |                  |                              |                                      |                        |                 |

NOTE: DEVELOPMENT PERMIT APPLICATION FORM MUST ACCOMPANY ALL OTHER COMMUNITY DEVELOPMENT DEPARTMENT APPLICATIONS



# VARIANCE APPLICATION

|                |                              |                                 |                                 |
|----------------|------------------------------|---------------------------------|---------------------------------|
| Project Number | Project Name (15 characters) | Case Number<br><i>19112-013</i> | Date Received<br><i>6/25/12</i> |
|----------------|------------------------------|---------------------------------|---------------------------------|

**TYPE OF VARIANCE REQUESTED:**

|                                                                        |                                                                  |
|------------------------------------------------------------------------|------------------------------------------------------------------|
| <input type="checkbox"/> Variance to the Sign Standard (VSG)           | <input type="checkbox"/> Variance to Dimensional Standards (VDS) |
| <input checked="" type="checkbox"/> Variance to Habitat Setbacks (VHB) | <input type="checkbox"/> Variance to Parking Requirements (VPK)  |
| <input type="checkbox"/> Variance to Setback Requirements (VSB)        |                                                                  |

**DESCRIPTION OF ACTIVITY WHICH REQUIRES A VARIANCE:**

DOT&PF is proposing to rehabilitate pavement on Glacier Hwy. from the Egan Drive intersection to the intersection of Egan Drive and Mendenhall Loop Road. There are two eagle nests located within 330 feet of the project.

**Previous Variance Applications?**  YES  NO Date of Filing: *2/25/09*

Previous Case Number(s): *VAR2009-00002 - this variance case is not for this same location*

Was the Variance Granted?  YES  NO

**UNIQUE CHARACTERISTICS OF LAND OR BUILDING(S):** \_\_\_\_\_

None  
\_\_\_\_\_  
\_\_\_\_\_

**UTILITIES AVAILABLE:** WATER:  Public  On Site SEWER:  Public  On Site

**WHY WOULD A VARIANCE BE NEEDED FOR THIS PROPERTY REGARDLESS OF THE OWNER?**

CBJ regulations state that a variance is needed when construction occurs less than 330 feet from an eagle nest.  
\_\_\_\_\_  
\_\_\_\_\_

**WHAT HARDSHIP WOULD RESULT IF THE VARIANCE WERE NOT GRANTED?**

Drivers would suffer the effects of traveling on a roadway with a deteriorating surface. Maintenance costs would be greater if the road is not repaired.  
\_\_\_\_\_  
\_\_\_\_\_

|                                                                                                                                                                                                                                                   |                      |                  |                  |                |                |
|---------------------------------------------------------------------------------------------------------------------------------------------------------------------------------------------------------------------------------------------------|----------------------|------------------|------------------|----------------|----------------|
| For more information regarding the permitting process and the submittals required for a complete application, please see the reverse side.<br><br>If you need any assistance filling out this form, please contact the Permit Center at 586-0770. | <b>VARIANCE FEES</b> |                  |                  |                |                |
|                                                                                                                                                                                                                                                   |                      | Fees             | Check No.        | Receipt        | Date           |
|                                                                                                                                                                                                                                                   | Application Fees     | \$ <i>400.00</i> | _____            | _____          | _____          |
|                                                                                                                                                                                                                                                   | Adjustment           | \$ _____         | _____            | _____          | _____          |
|                                                                                                                                                                                                                                                   | Total Fee            | \$ <i>400.00</i> | <i>211439714</i> | <i>Edw 217</i> | <i>6/25/12</i> |

**NOTE: MUST BE ACCOMPANIED BY DEVELOPMENT PERMIT APPLICATION FORM**

RECEIVED  
 JUN 13 2012  
 DOT-JUNEAU FISCAL

TO BE COMPLETED BY THE APPLICANT

# STATE OF ALASKA

## DEPARTMENT OF TRANSPORTATION AND PUBLIC FACILITIES

*Southeast Region Design & Engineering Services  
Preliminary Design & Environmental Section*

SEAN PARNELL, GOVERNOR

6860 Glacier Highway  
P.O. Box 112506  
Juneau, Alaska 99811-2506  
Phone: 907-465-4234  
1-800-575-4540  
Fax: 907-465-3506  
TTY: 1-800-770-8255

June 12, 2012

Planning Commission,  
City/Borough of Juneau  
155 Seward St.  
Juneau, AK 99801

RECEIVED  
JUN 21 2012  
PLANNING COMMISSION

RE: Glacier Highway Pavement Rehabilitation, Project # 67432-Variance Application

To the Planning Commission:

Please accept the accompanying variance application and supporting material regarding a variance for an eagle disturbance. The DOT&PF is proposing to construct a pavement rehabilitation project on Glacier Highway and Channel Drive in Juneau. There are 2 eagle nests located less than 330 feet from the project area at the Glacier Highway segment of the project so a variance will be required. The accompanying materials offers a description of the project location and details. Also included is a copy of a letter from USF&WS stating why DOT&PF will not be applying for an eagle disturbance permit for this project. If you have any questions please do not hesitate to contact me.

Sincerely,



Jane Gendron  
Southeast Region, Environmental Manager

Enclosures:

Variance Application  
Project Development Application  
Project Description  
6-8-12 Letter, USFWS  
Project Area Maps (1-6 of 6)  
Plan Set, F-Sheets Only

RECEIVED  
JUN 13 2012  
DOT-JUNEAU FISCAL

RECEIVED  
 JUN 25 2012  
 PERMIT CENTER/CDD

This space left blank intentionally

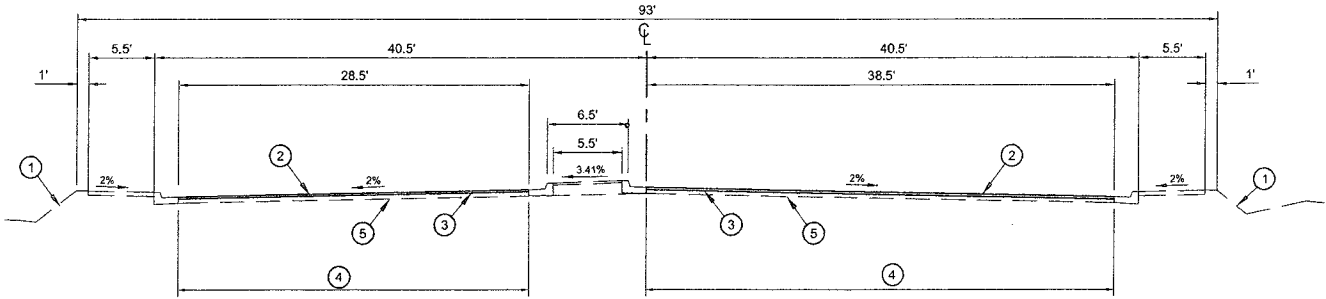

GLACIER HIGHWAY EGAN EXPRESSWAY (BOP)  
 TO JORDAN AVENUE  
 NTS

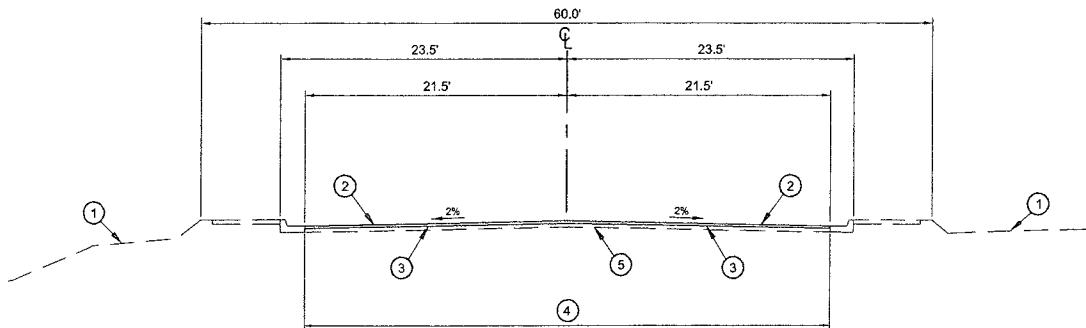

GLACIER HIGHWAY JORDAN AVENUE TO  
 MENDENHALL LOOP INTERSECTION (EOP)  
 NTS

**LEGEND**

- ① EXISTING GROUND
- ② 2" ASPHALT CONCRETE PAVEMENT, TYPE SP
- ③ STE-1 ASPHALT TACK COAT BETWEEN ATB/ATB & ATB/ACP, & ACP/EXISTING PAVEMENT LAYERS
- ④ PAVEMENT COLD PLANING
- ⑤ EXISTING AC
- ⑥ EXISTING RETAINING WALL

WATER BODIES:  
 GASTINEAU CHANNEL

**TYPICAL SECTIONS**  
 APPLICATION BY:  
 ALASKA STATE DEPT. OF TRANSPORTATION  
 AND PUBLIC FACILITIES  
 SOUTHEAST REGION

JNU AREA WIDE ROAD  
 PAVEMENT REHABILITATION  
 PROJECT #67432  
 AT: JUNEAU, ALASKA  
 LOCATED IN: SECTION 5, T42S, R68E  
 COPPER RIVER MERIDIAN  
 JUNEAU B-1  
 QUADRANGLE MAP  
 DATE: MAY 7, 2012 SHEET 5 OF 6

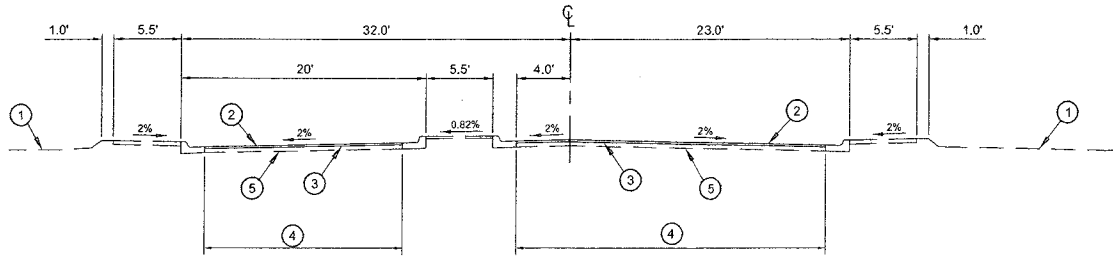

GLACIER HIGHWAY MEDIAN SECTION - 1  
NTS

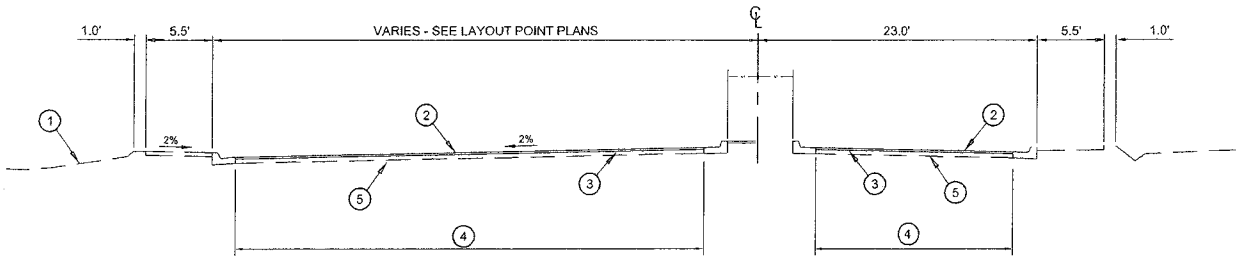

GLACIER HIGHWAY MEDIAN SECTION - 2  
NTS

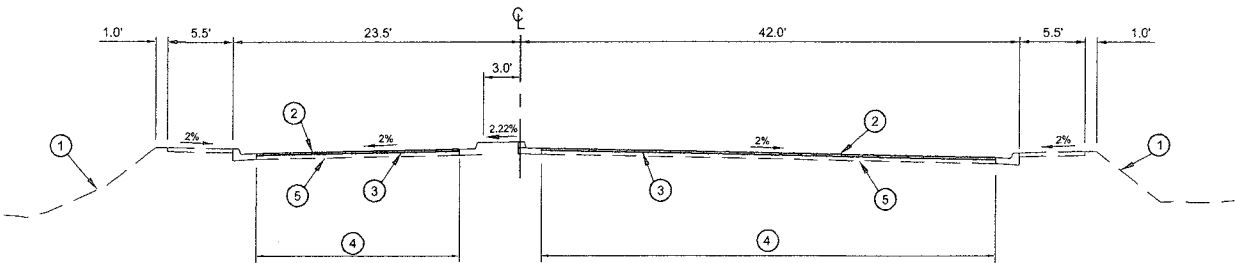

GLACIER HIGHWAY MEDIAN SECTION - 3  
NTS

| LEGEND |                                                                                   |
|--------|-----------------------------------------------------------------------------------|
| ①      | EXISTING GROUND                                                                   |
| ②      | 2" ASPHALT CONCRETE PAVEMENT, TYPE SP                                             |
| ③      | STE-1 ASPHALT TACK COAT BETWEEN ATB/ATB & ATB/ACP, & ACP/EXISTING PAVEMENT LAYERS |
| ④      | PAVEMENT COLD PLANING                                                             |
| ⑤      | EXISTING AC                                                                       |

WATER BODIES:  
GASTINEAU CHANNEL

## TYPICAL SECTIONS

APPLICATION BY:  
ALASKA STATE DEPT. OF TRANSPORTATION  
AND PUBLIC FACILITIES  
SOUTHEAST REGION

JNU AREA WIDE ROAD  
PAVEMENT REHABILITATION  
PROJECT #67432

AT: JUNEAU, ALASKA  
LOCATED IN: SECTION-5, T42S, R68E  
COPPER RIVER MERIDIAN  
JUNEAU B-1  
QUADRANGLE MAP

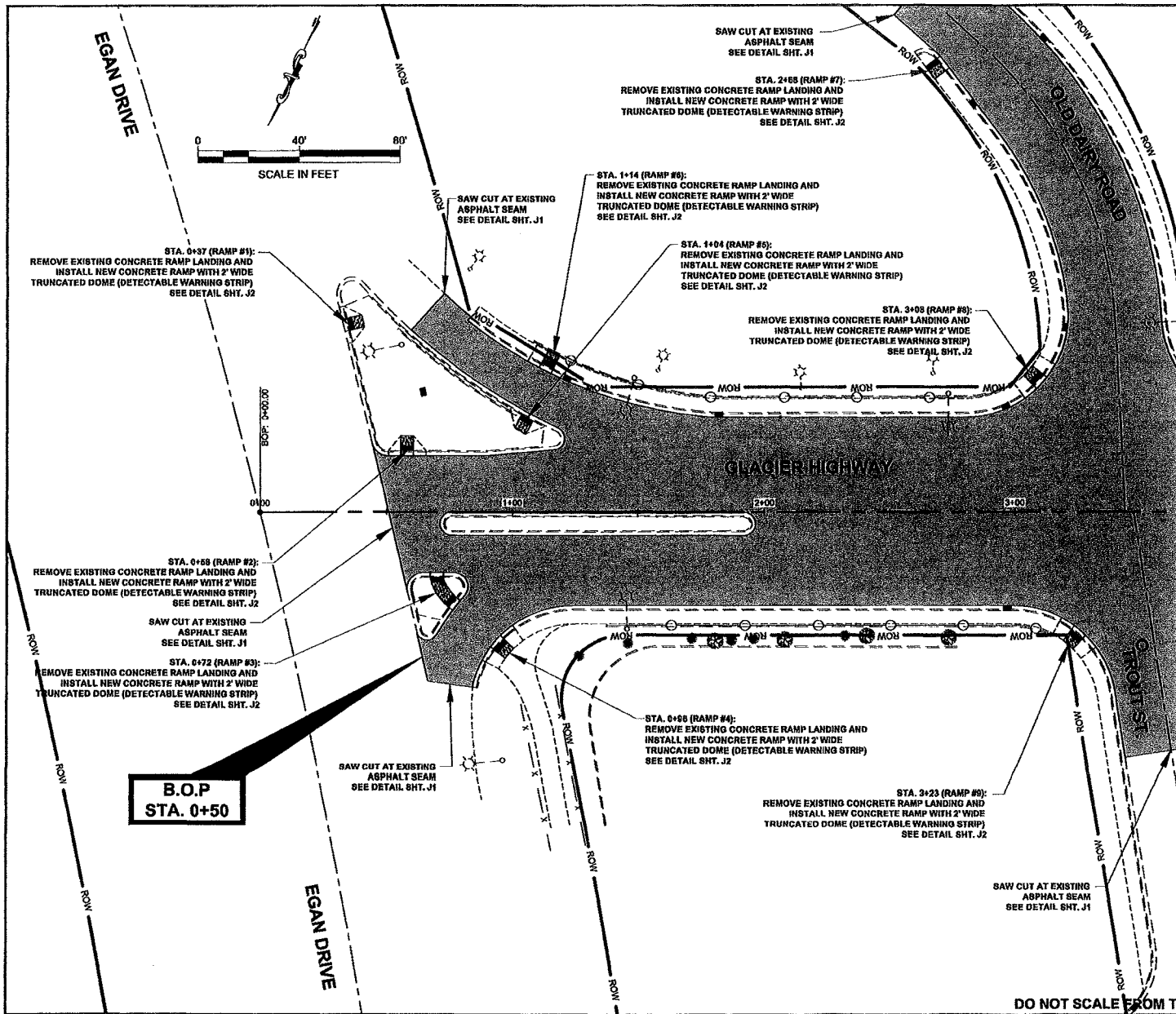

DATE: MAY 7, 2012 SHEET 6 OF 6



MATCH LINE STA. 3+65.00

RECEIVED  
 JUN 25 2012  
 PERMIT CENTER/CDD

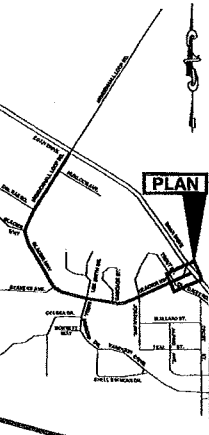
DO NOT SCALE FROM THESE DRAWINGS USE DIMENSIONS

|                                                                                                                                                                              |              |             |
|------------------------------------------------------------------------------------------------------------------------------------------------------------------------------|--------------|-------------|
| PATH: \\MINI08\43\36\00\00'S<br><b>PLANSHEET PLAN GLACIER</b><br>HIGHWAY 2000<br>MULLNER, DOUGLAS J (DOT)<br>TAB: F1    Tuesday, June 19, 2012 9:43:41 AM<br>APPENDIX NUMBER |              |             |
| ATTACHMENT NUMBER                                                                                                                                                            |              |             |
| RECORD OF REVISIONS                                                                                                                                                          |              |             |
| No.                                                                                                                                                                          | DATE         | DESCRIPTION |
|                                                                                                                                                                              |              |             |
|                                                                                                                                                                              |              |             |
|                                                                                           |              |             |
| JUREAU<br>INTERNATIONAL<br>AIRPORT                                                                                                                                           |              |             |
| <b>PLAN LEGEND</b>                                                                                                                                                           |              |             |
| CHECKED BY: K. KARPSTEIN                                                                                                                                                     |              |             |
|                                                                                           |              |             |
| DESIGNED BY: D. MULLNER                                                                                                                                                      |              |             |
| DRAWN BY: D. MULLNER                                                                                                                                                         |              |             |
| STATE OF ALASKA<br>DEPARTMENT OF TRANSPORTATION<br>& PUBLIC FACILITIES<br>SOUTHEAST REGION                                                                                   |              |             |
| JNU-FY12 AREAWIDE PAVING<br>GLACIER HIGHWAY<br>PROJECT #67432                                                                                                                |              |             |
| <b>PLAN</b>                                                                                                                                                                  |              |             |
| PROJECT DESIGNATION                                                                                                                                                          |              |             |
| <b>EAP-000S(813) ~ 67432</b>                                                                                                                                                 |              |             |
| STATE                                                                                                                                                                        | YEAR         |             |
| <b>ALASKA</b>                                                                                                                                                                | <b>2012</b>  |             |
| SHEET NUMBER                                                                                                                                                                 | TOTAL SHEETS |             |
| <b>F1</b>                                                                                                                                                                    | <b>XX</b>    |             |

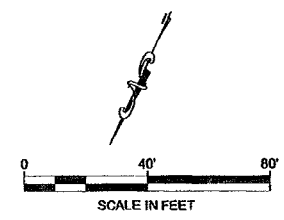
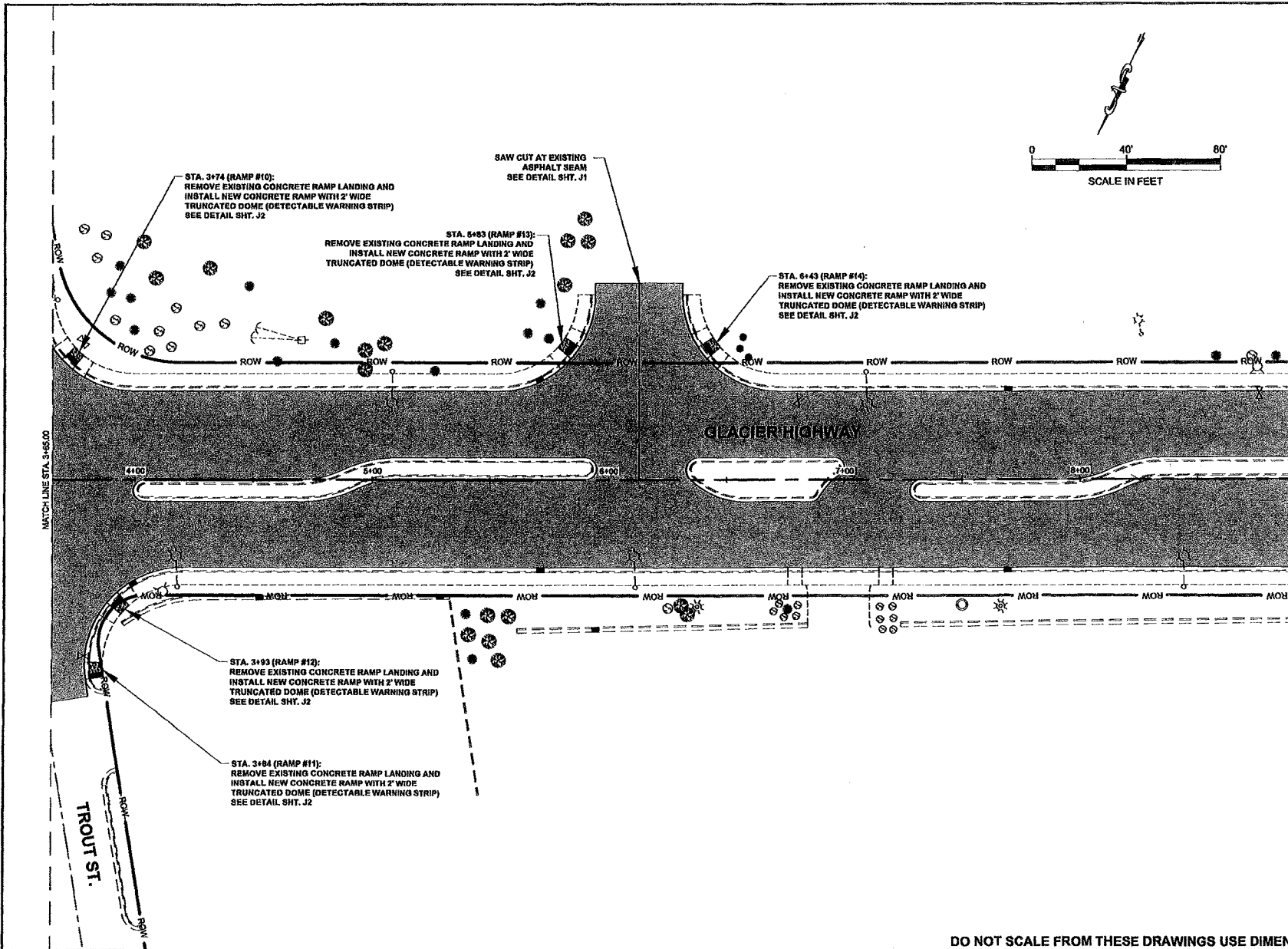

PATH: G:\LINE\7437E\000\00\0\ PLANSET\ PLAN\_GLAcier HIGHWAY.DWG

MULLINER, DOUGLAS J (DOT)

TAB: F2 Thursday, June 14, 2012 8:58:11 AM

ADDENDUM NUMBER

ATTACHMENT NUMBER

RECORD OF REVISIONS

| No. | DATE | DESCRIPTION |
|-----|------|-------------|
|     |      |             |
|     |      |             |

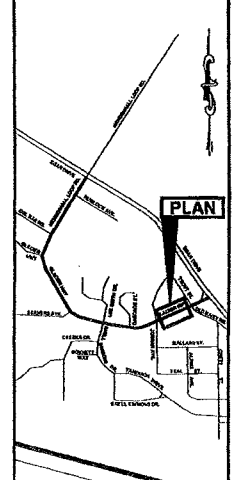

**JUNEAU INTERNATIONAL AIRPORT**

**PLAN LEGEND**

CHECKED BY: K. KARPSTEIN



DESIGNED BY: D. MULLINER

DRAWN BY: D. MULLINER

STATE OF ALASKA  
DEPARTMENT OF TRANSPORTATION  
& PUBLIC FACILITIES  
SOUTHWEST REGION

JNU-FFY12 AREAWIDE PAVING  
GLACIER HIGHWAY  
PROJECT #67432

**PLAN**

PROJECT DESIGNATION  
**EAP-000S(813) ~ 67432**

| STATE         | YEAR         |
|---------------|--------------|
| <b>ALASKA</b> | <b>2012</b>  |
| SHEET NUMBER  | TOTAL SHEETS |
| <b>F2</b>     | <b>XX</b>    |

**DO NOT SCALE FROM THESE DRAWINGS USE DIMENSIONS**

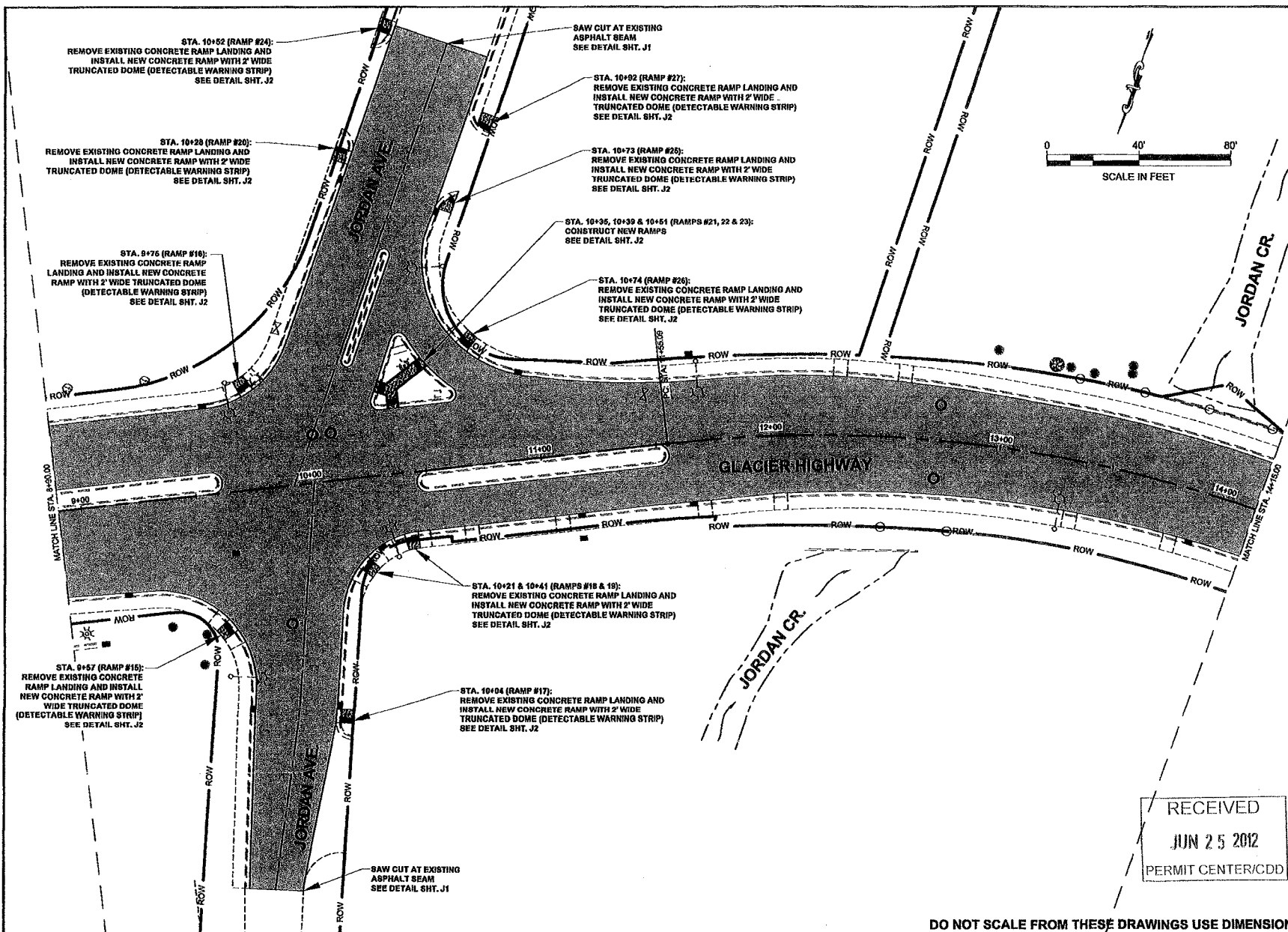

PATHQA100474328END00'S  
 PLANSET: PLAN\_GLACIER  
 HIGHWAY 200'S  
 MULLINER, DOUGLAS J. (DOT)  
 TAB: F3 Tuesday, June 12, 2012 8:58:23 AM

ATTACHMENT NUMBER

RECORD OF REVISIONS

| No. | DATE | DESCRIPTION |
|-----|------|-------------|
|     |      |             |

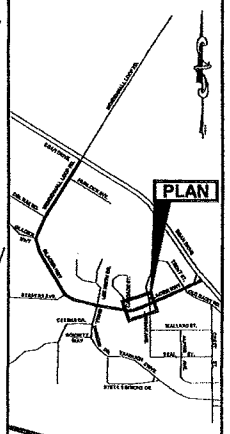
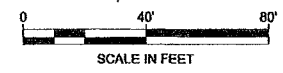

JURAEAL  
 INTERNATIONAL  
 AIRPORT

PLAN LEGEND



DESIGNED BY: D. MULLINER

DRAWN BY: D. MULLINER

STATE OF ALASKA  
 DEPARTMENT OF TRANSPORTATION  
 & PUBLIC FACILITIES  
 SOUTHEAST REGION

JNU-FY12 AREAWIDE PAVING  
 GLACIER HIGHWAY  
 PROJECT #67432

RECEIVED  
 JUN 25 2012  
 PERMIT CENTER/CDD

PLAN

PROJECT DESIGNATION  
 EAP-000S(813) ~ 67432

| STATE        | YEAR         |
|--------------|--------------|
| ALASKA       | 2012         |
| SHEET NUMBER | TOTAL SHEETS |
| F3           | XX           |

DO NOT SCALE FROM THESE DRAWINGS USE DIMENSIONS

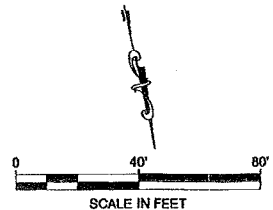
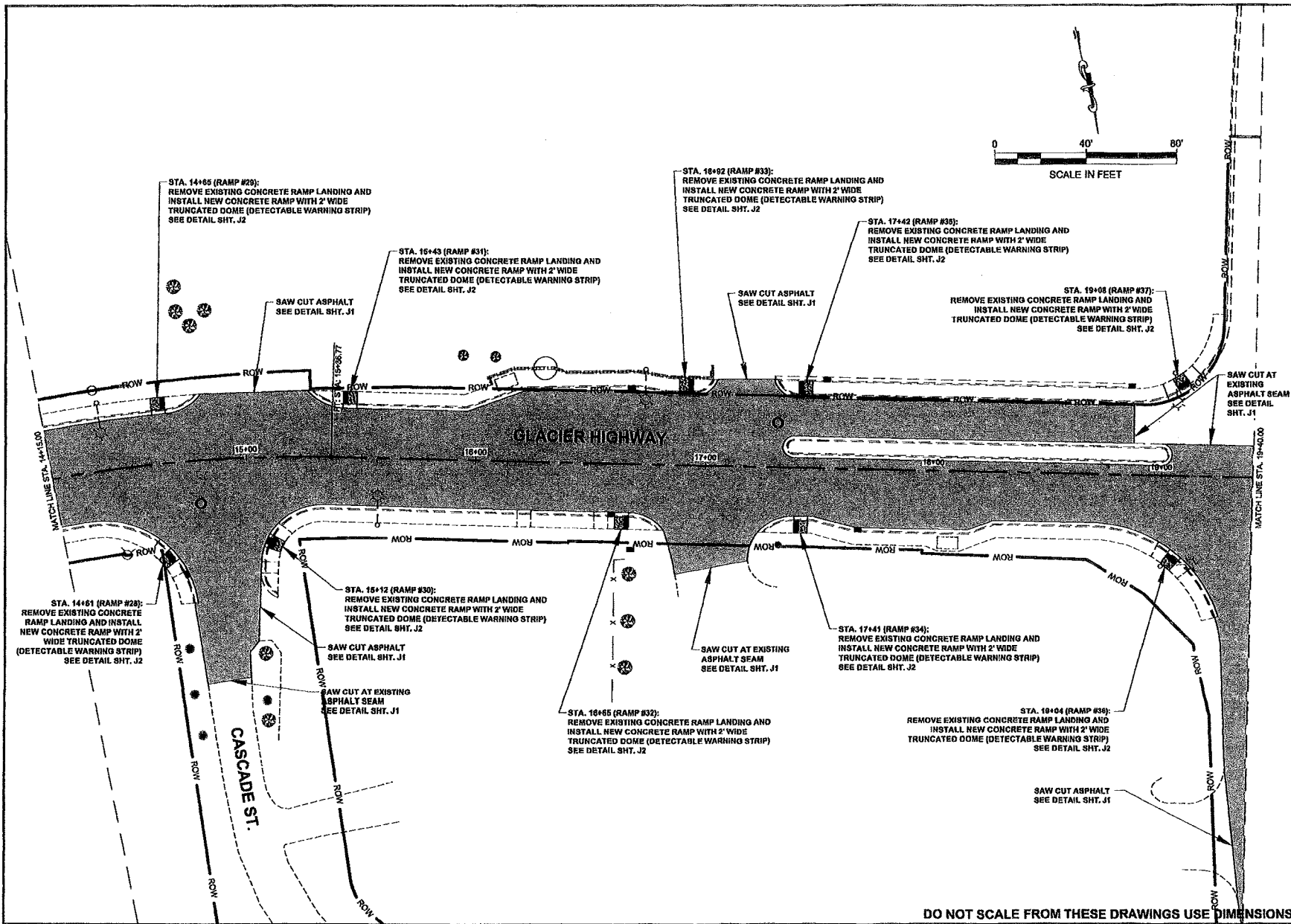

PATH: Q:\JUN12\F4\3\REMOVAL PLAN\_SHEET PLAN\_GLACIER HIGHWAY.DWG  
 MULLNER, DOUGLAS J (DOT)  
 TWR F4 Tuesday, June 12, 2012 2:56:38 AM  
 ADOPTION NUMBER  
 ATTACHMENT NUMBER  
 RECORD OF REVISIONS  
 No. DATE DESCRIPTION

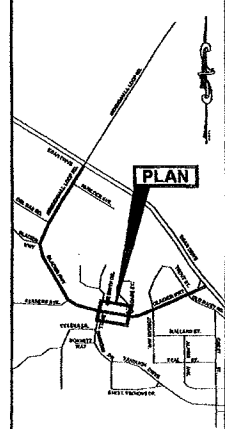

JUNEAU INTERNATIONAL AIRPORT  
**PLAN LEGEND**

CHECKED BY: K. KARP-SIEN

DESIGNED BY: D. MULLNER  
 DRAWN BY: D. MULLNER  
 STATE OF ALASKA  
 DEPARTMENT OF TRANSPORTATION  
 & PUBLIC FACILITIES  
 SOUTHEAST REGION  
 JUNU-FY12 AREAWIDE PAVING  
 GLACIER HIGHWAY  
 PROJECT #67432

**PLAN**  
 PROJECT DESIGNATION

**EAP-000S(813) ~ 67432**

|              |              |
|--------------|--------------|
| STATE        | YEAR         |
| ALASKA       | 2012         |
| SHEET NUMBER | TOTAL SHEETS |
| F4           | XX           |

DO NOT SCALE FROM THESE DRAWINGS USE DIMENSIONS



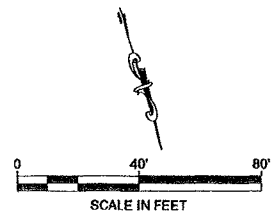
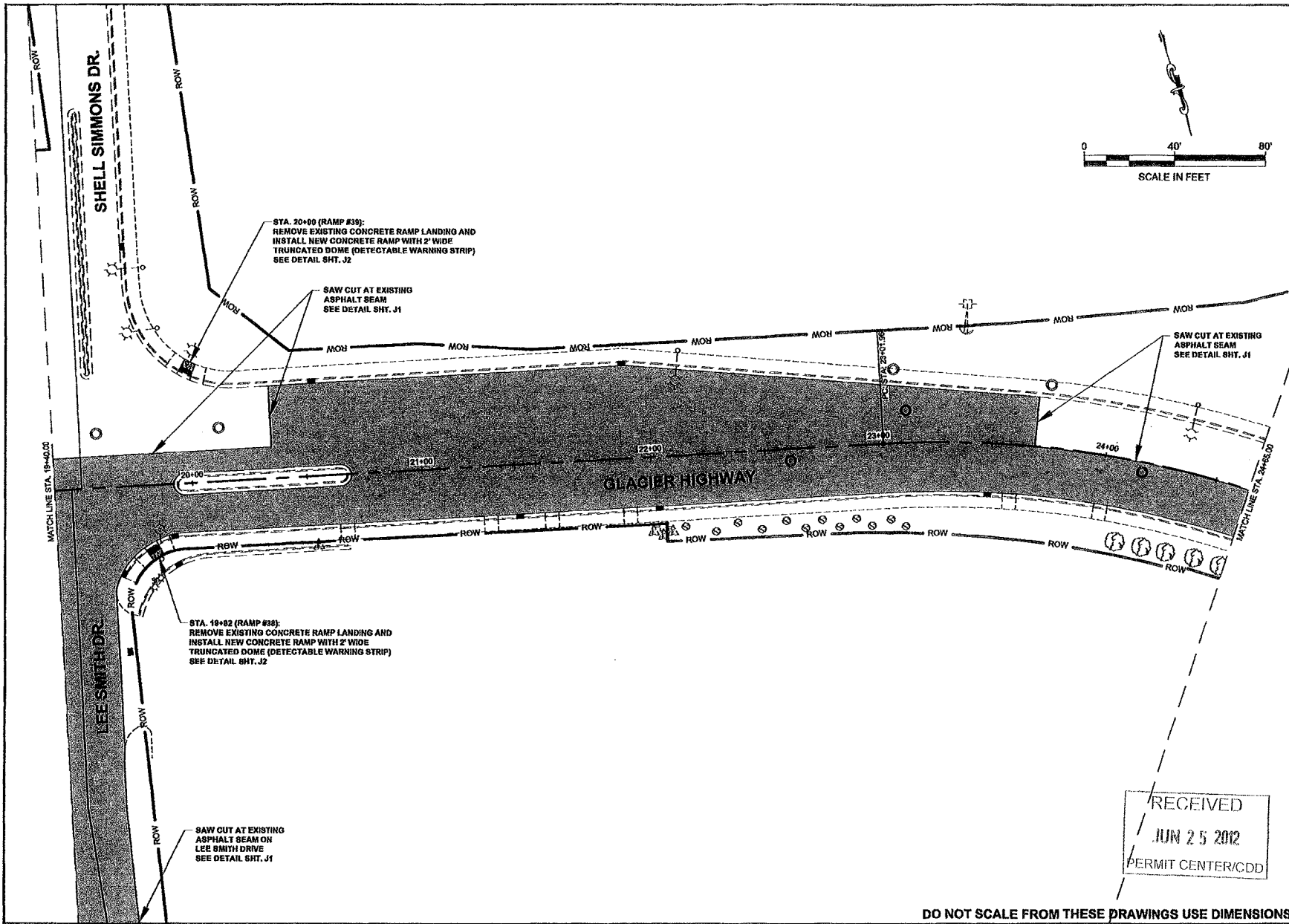

PATH: Q:\JUN08\7432\KMD000'S  
 PLANVIEW PLAN, GLACIER  
 HIGHWAY.DWG  
 MULLINER, DOUGLAS J (DOT)  
 TAD: F8 Tuesday, June 12, 2012 8:56:37 AM  
 ADDENDUM NUMBER

ATTACHMENT NUMBER

RECORD OF REVISIONS

| No. | DATE | DESCRIPTION |
|-----|------|-------------|
|     |      |             |
|     |      |             |
|     |      |             |

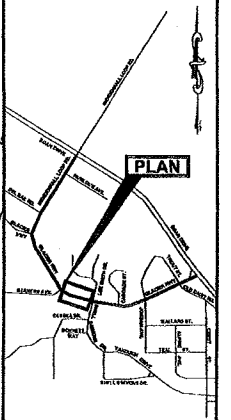

JUNEAU INTERNATIONAL AIRPORT

**PLAN LEGEND**

CHECKED BY: K. KARPSTEN

DESIGNED BY: D. MULLINER  
 DRAWN BY: D. MULLINER

STATE OF ALASKA  
 DEPARTMENT OF TRANSPORTATION  
 & PUBLIC FACILITIES  
 SOUTHEAST REGION

JUN-FFY12 AREAWIDE PAVING  
 GLACIER HIGHWAY  
 PROJECT #67432

RECEIVED  
 JUN 25 2012  
 PERMIT CENTER/CDD

DO NOT SCALE FROM THESE DRAWINGS USE DIMENSIONS

PROJECT DESIGNATION

**EAP-000S(813) ~ 67432**

| STATE        | YEAR         |
|--------------|--------------|
| ALASKA       | 2012         |
| SHEET NUMBER | TOTAL SHEETS |
| F5           | XX           |

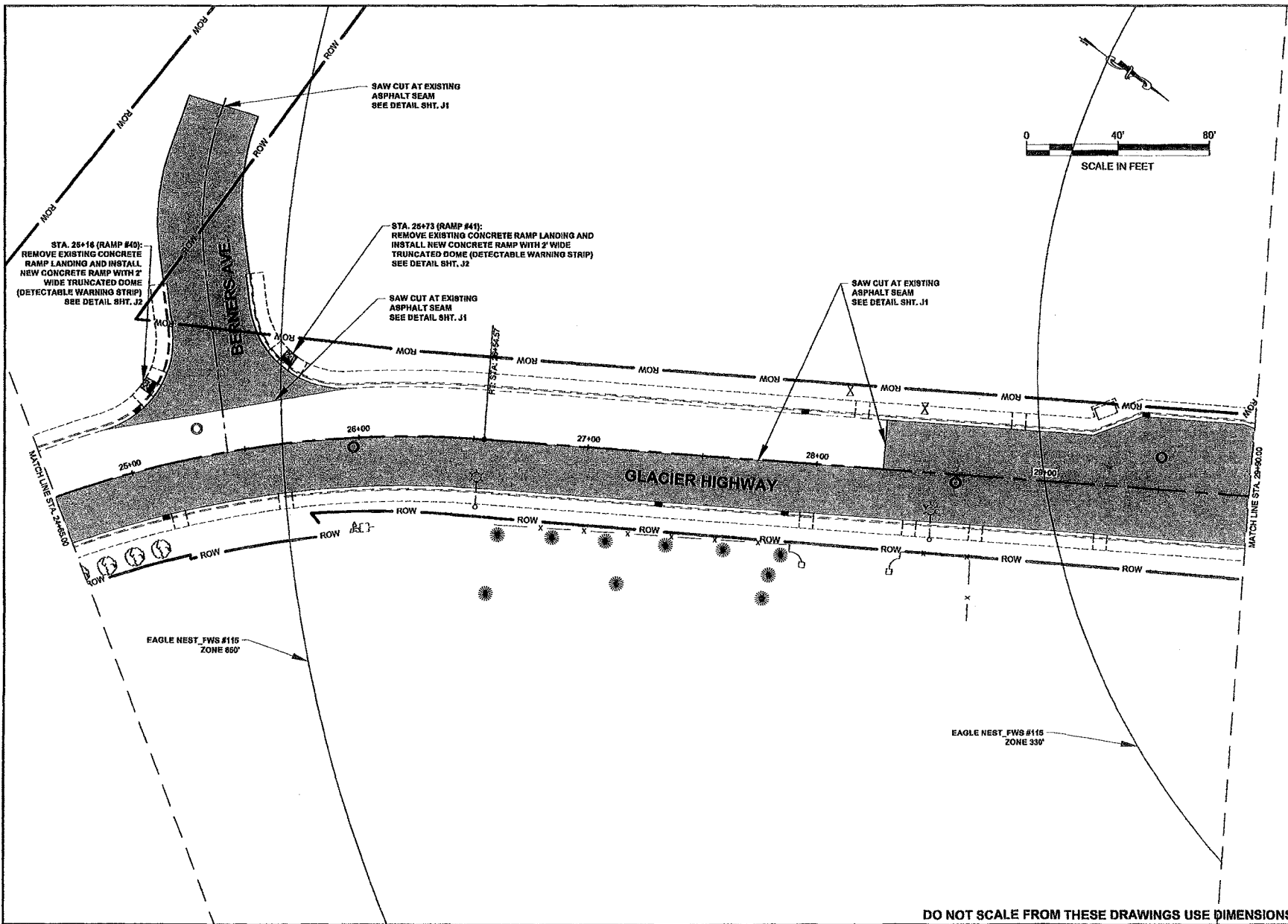

PATH:G:\JUN06\4358\000\0\0\PLAN\REV. PLAN, GLACIER HIGHWAY.DWG  
 MULLINER, DOUGLAS J (DOJ)  
 TAB. F6 Tuesday, June 12, 2012 8:51:12 AM  
 ADDENDUM NUMBER  
 ATTACHMENT NUMBER  
 RECORD OF REVISIONS  
 NO. DATE DESCRIPTION

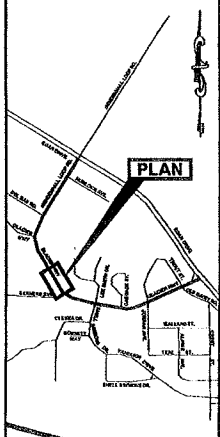

JUREAU  
 INTERNATIONAL  
**PLAN LEGEND**



DESIGNED BY: D. MULLINER  
 DRAWN BY: D. MULLINER  
 STATE OF ALASKA  
 DEPARTMENT OF TRANSPORTATION  
 & PUBLIC FACILITIES  
 SOUTHEAST REGION  
 JNU-FFY12 AREAWIDE PAVING  
 GLACIER HIGHWAY  
 PROJECT #67432

**PLAN**

PROJECT DESIGNATION  
**EAP-000S(813) ~ 67432**

|              |              |
|--------------|--------------|
| STATE        | YEAR         |
| ALASKA       | 2012         |
| SHEET NUMBER | TOTAL SHEETS |
| F6           | XX           |

DO NOT SCALE FROM THESE DRAWINGS USE DIMENSIONS

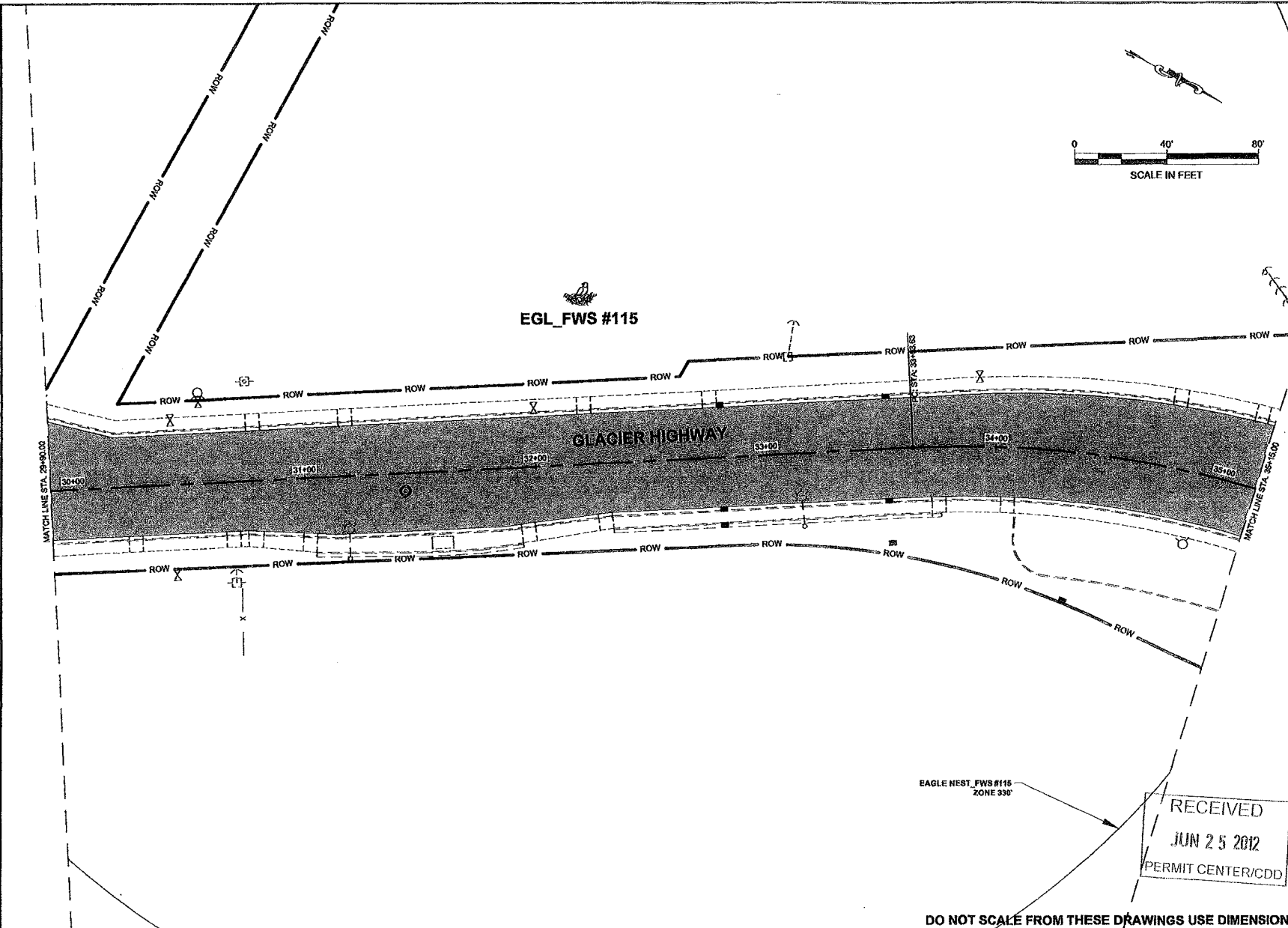

PATH: Q:\SHEETS\67432\REV\DOUG'S  
 PLANSET: PLAN\_GLACIER  
 HIGHWAY.DWG  
 MULLNER, DOUGLAS J (DOT)  
 TAB: F7 Tuesday, June 12, 2012 8:57:26 AM  
 APPENDIX NUMBER  
 ATTACHMENT NUMBER  
 RECORD OF REVISIONS  
 No. DATE DESCRIPTION

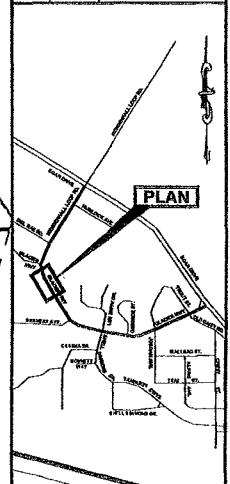

JUNEAU  
 INTERNATIONAL  
 AIRPORT  
**PLAN LEGEND**

CHECKED BY: K. KARPSTEIN

DESIGNED BY: D. MULLNER  
 DRAWN BY: D. MULLNER  
 STATE OF ALASKA  
 DEPARTMENT OF TRANSPORTATION  
 & PUBLIC FACILITIES  
 SOUTHEAST REGION  
 JNU-FY12 AREAWIDE PAVING  
 GLACIER HIGHWAY  
 PROJECT #67432

RECEIVED  
 JUN 25 2012  
 PERMIT CENTER/CDD

**PLAN**  
 PROJECT DESIGNATION  
**EAP-000S(813) ~ 67432**  

|               |              |
|---------------|--------------|
| STATE         | YEAR         |
| <b>ALASKA</b> | <b>2012</b>  |
| SHEET NUMBER  | TOTAL SHEETS |
| <b>F7</b>     | <b>XX</b>    |

DO NOT SCALE FROM THESE DRAWINGS USE DIMENSIONS

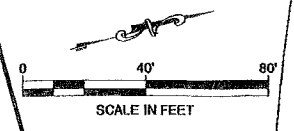
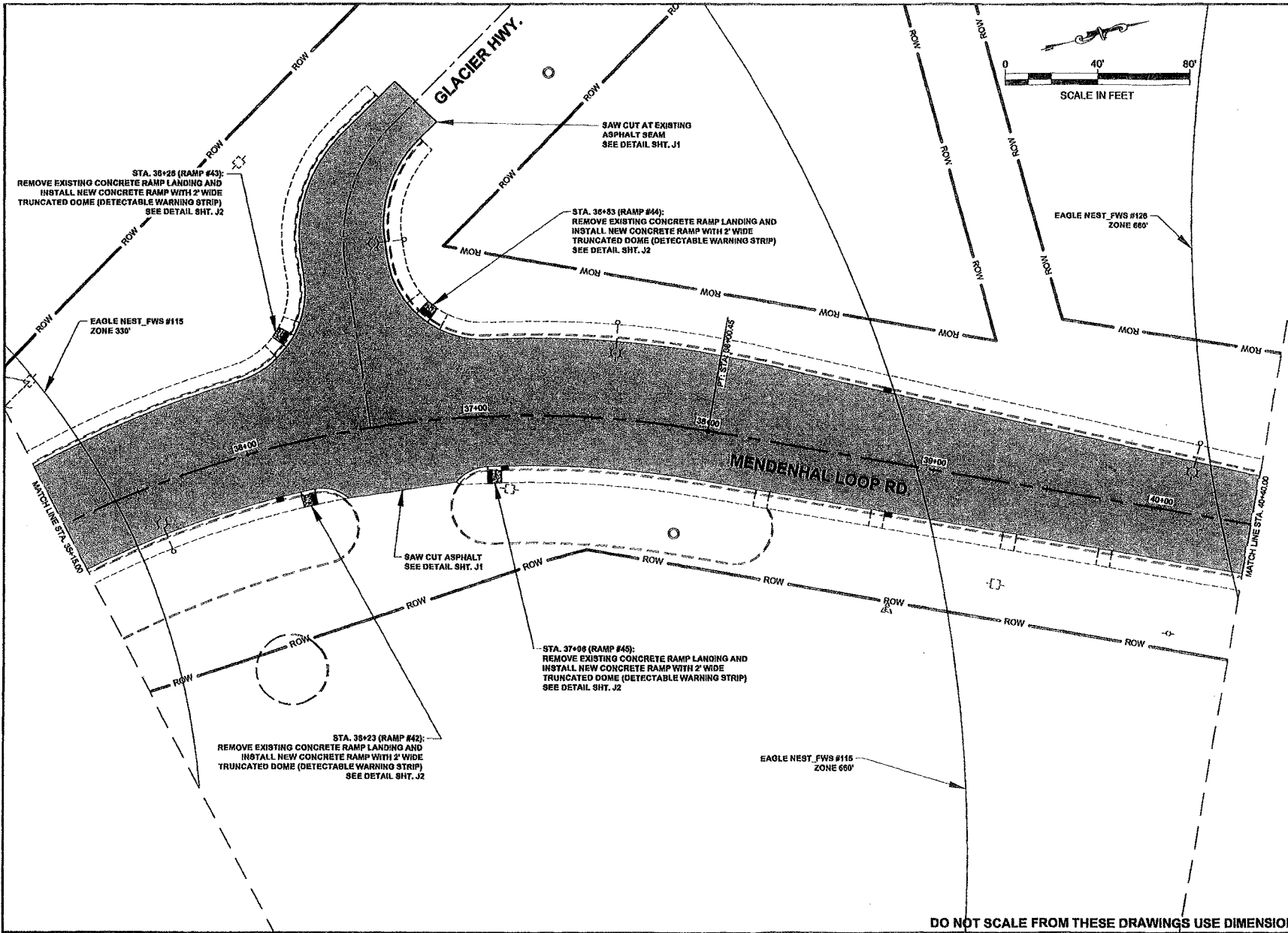

PATH:\SHUM\432\FM\010\PLANSET\FW\_PLAN\_GLACIER HIGHWAY.DWG  
 MULLINER, DOUGLAS J (DOT)  
 TAB: F8 Tuesday, June 22, 2012 8:37:58 AM  
 ADDRESS NUMBER  
 ATTACHMENT NUMBER

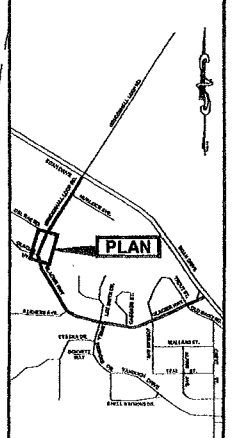

JUNEAU INTERNATIONAL AIRPORT  
**PLAN LEGEND**

CHECKED BY: K KARPSTEIN

DESIGNED BY: D. MULLINER  
 DRAWN BY: D. MULLINER  
 STATE OF ALASKA  
 DEPARTMENT OF TRANSPORTATION & PUBLIC FACILITIES  
 SOUTHEAST REGION  
 JNU-FY12 AREAWIDE PAVING  
 GLACIER HIGHWAY  
 PROJECT #67432

**PLAN**

PROJECT DESIGNATION  
**EAP-000S(813) ~ 67432**

| STATE        | YEAR         |
|--------------|--------------|
| ALASKA       | 2012         |
| SHEET NUMBER | TOTAL SHEETS |
| F8           | XX           |

DO NOT SCALE FROM THESE DRAWINGS USE DIMENSIONS

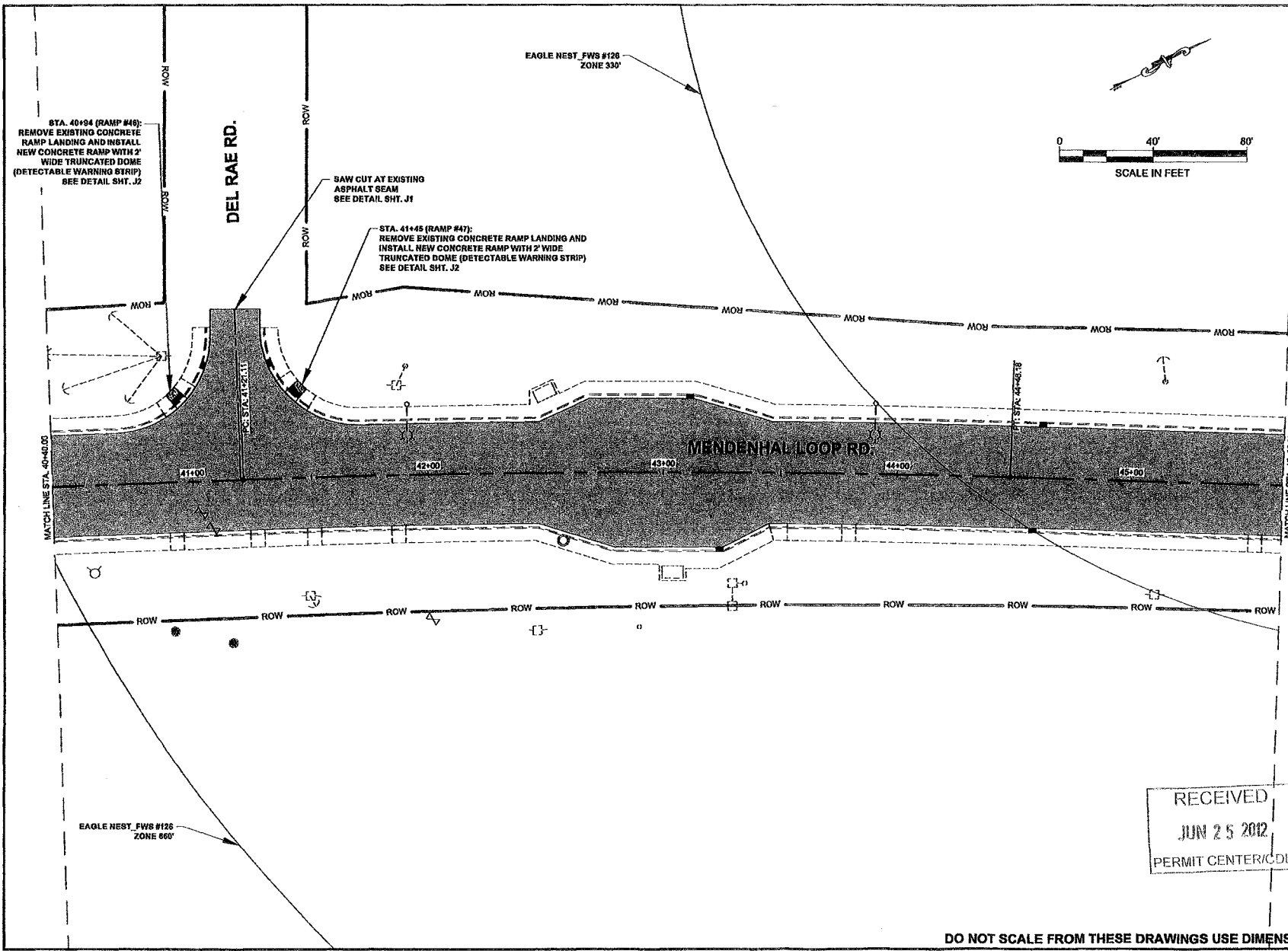

PATH 03 UNIMATED POND DUG'S  
 PLAN SET: PLAN GLACIER  
 HIGHWAY.DWG  
 MULLINER, DOUGLAS J (DOT)  
 TAB: F9 Tuesday, June 12, 2012 8:57:49 AM  
 APPENDIX NUMBER  
 ATTACHMENT NUMBER

RECORD OF REVISIONS

| No. | DATE | DESCRIPTION |
|-----|------|-------------|
|     |      |             |
|     |      |             |

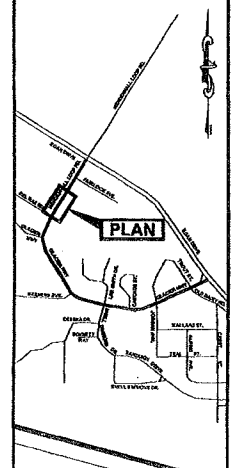
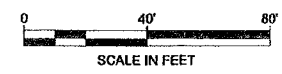

JUREAU INTERNATIONAL AIRPORT  
**PLAN LEGEND**

CHECKED BY: K. KARPSTERN

DESIGNED BY: D. MULLINER  
 DRAWN BY: D. MULLINER  
 STATE OF ALASKA  
 DEPARTMENT OF TRANSPORTATION  
 & PUBLIC FACILITIES  
 SCHEMATIC REGION  
 JNU-FFY12 AREAWIDE PAVING  
 GLACIER HIGHWAY  
 PROJECT #67432

RECEIVED  
 JUN 25 2012  
 PERMIT CENTER/CDD

**PLAN**

PROJECT DESIGNATION  
**EAP-000S(813) ~ 67432**

| STATE        | YEAR         |
|--------------|--------------|
| ALASKA       | 2012         |
| SHEET NUMBER | TOTAL SHEETS |
| F9           | XX           |

DO NOT SCALE FROM THESE DRAWINGS USE DIMENSIONS

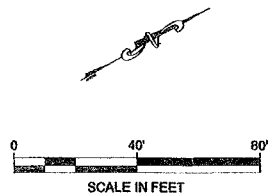
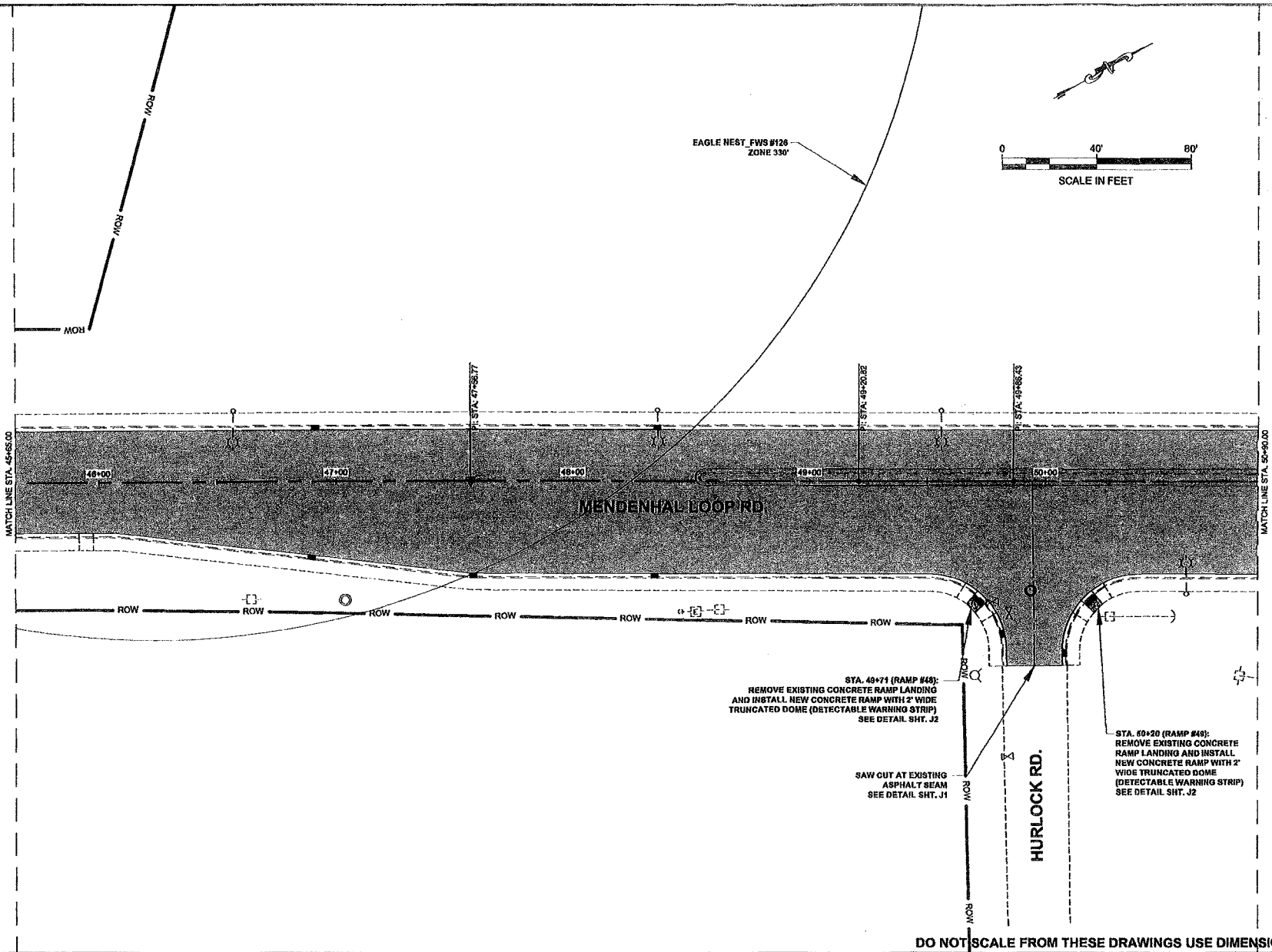

PATH: G:\JUN12\8743\REV\DOUG'S  
 PLANSET: PLAN\_GLACIER  
 HIGHWAY.DWG

MULLNER, DOUGLAS J (DOT)  
 TAB: F10 Tuesday, June 12, 2012 8:58:04 AM  
 APPENDIX NUMBER

ATTACHMENT NUMBER

RECORD OF REVISIONS

| No. | DATE | DESCRIPTION |
|-----|------|-------------|
|     |      |             |

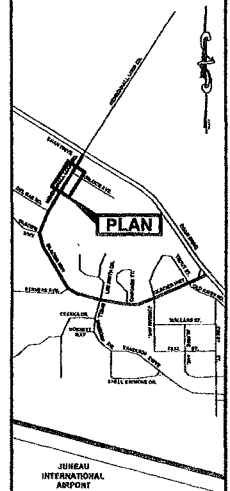

**PLAN LEGEND**

CHECKED BY: K. KARDSTERN

DESIGNED BY: D. MULLNER

DRAWN BY: D. MULLNER

STATE OF ALASKA  
 DEPARTMENT OF TRANSPORTATION  
 & PUBLIC FACILITIES  
 COURTESY PROGRAM

JUN-FFY12 AREAWIDE PAVING  
 GLACIER HIGHWAY  
 PROJECT #67432

**PLAN**

PROJECT DESIGNATION  
**EAP-000S(813) ~ 67432**

|              |              |
|--------------|--------------|
| STATE        | YEAR         |
| ALASKA       | 2012         |
| SHEET NUMBER | TOTAL SHEETS |
| F10          | XX           |

DO NOT SCALE FROM THESE DRAWINGS USE DIMENSIONS

PATH: G:\LNU\14742\RD000\PLANS\SETUP\_PLANS\_GLACIER HIGHWAY.DWG  
 MULLIKER, DOUGLAS J (DOT)  
 TAB: F11 Thursday, June 14, 2012 9:44:03 AM  
 ADDENDUM NUMBER  
 ATTACHMENT NUMBER  
 RECORD OF REVISIONS  
 NO. DATE DESCRIPTION

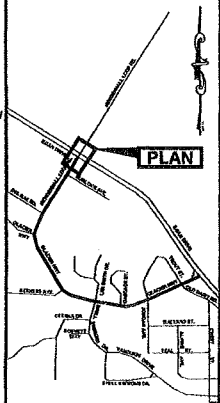

JUNEAU INTERNATIONAL AIRPORT  
**PLAN LEGEND**  
 CHECKED BY: K. KARPSTEIN



DESIGNED BY: D. MULLIKER  
 DRAWN BY: D. MULLIKER  
 STATE OF ALASKA  
 DEPARTMENT OF TRANSPORTATION  
 & PUBLIC FACILITIES  
 SOUTHEAST REGION  
 JNU-FFY12 AREAWIDE PAVING  
 GLACIER HIGHWAY  
 PROJECT #67432

RECEIVED  
 JUN 25 2012  
 PERMIT CENTER/CDD

**PLAN**

PROJECT DESIGNATION:  
**EAP-000S(813) ~ 67432**

|              |              |
|--------------|--------------|
| STATE        | YEAR         |
| ALASKA       | 2012         |
| SHEET NUMBER | TOTAL SHEETS |
| F11          | XX           |

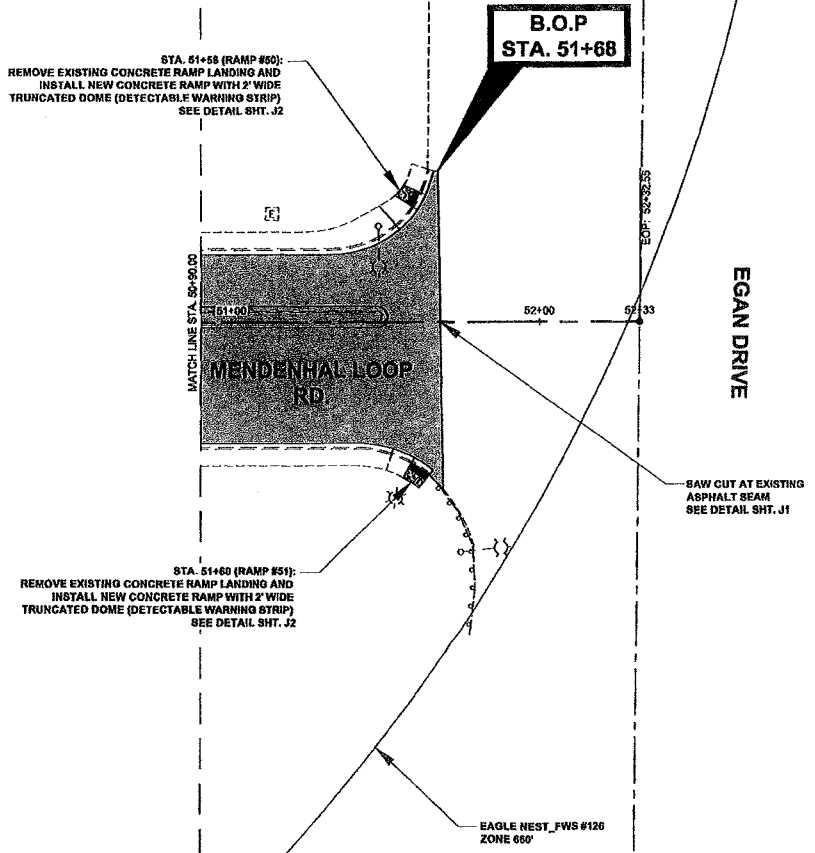

DO NOT SCALE FROM THESE DRAWINGS USE DIMENSIONS

# NOTICE OF PUBLIC HEARING

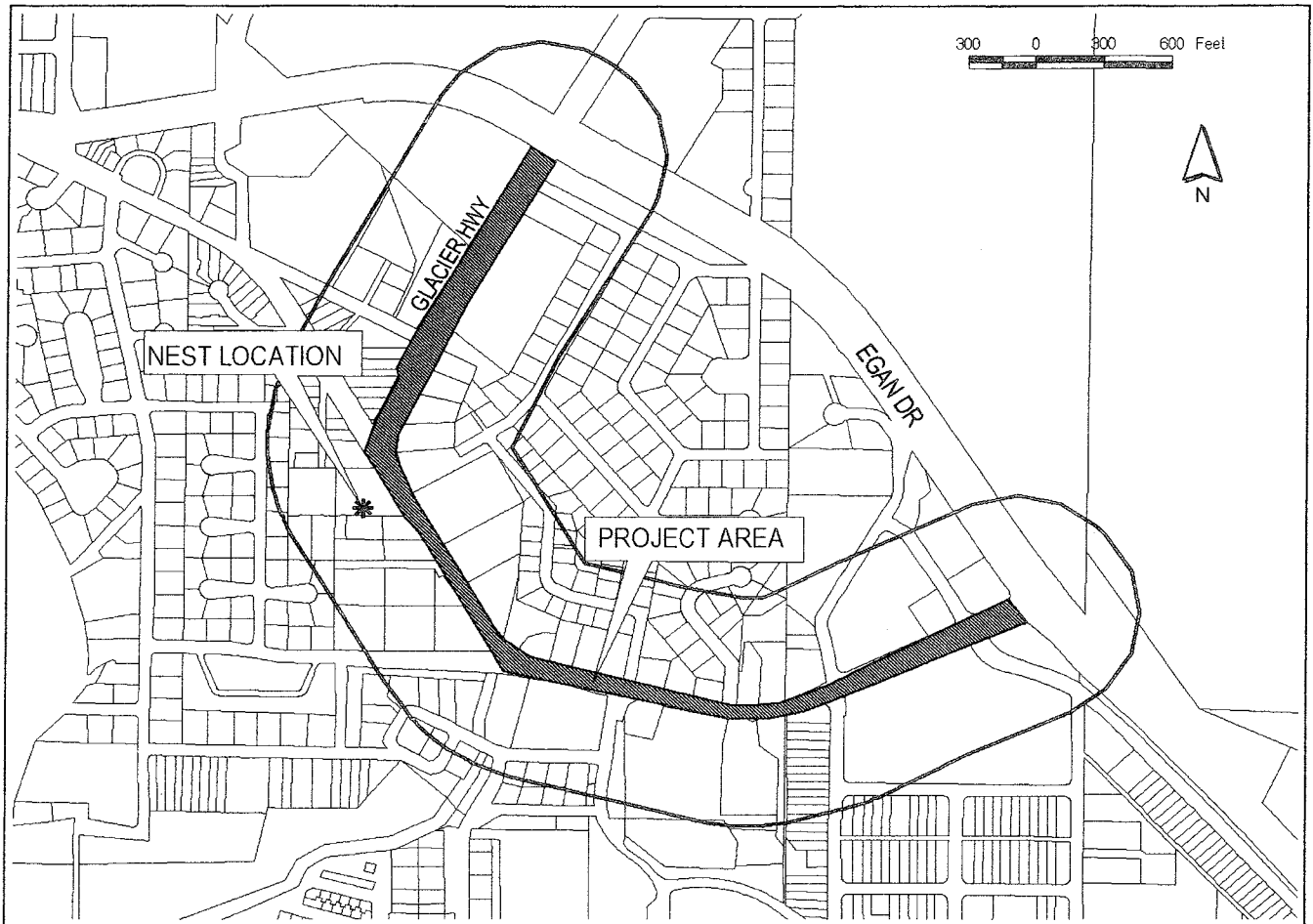

**PROPOSAL:** Variance request to allow a DOT/PF road rehabilitation project along Glacier Highway between McDonalds and the Skate Park within the 330 foot setback of an eagle nest.

|                      |                                                                                            |                        |                                                       |
|----------------------|--------------------------------------------------------------------------------------------|------------------------|-------------------------------------------------------|
| <b>FILE NO.:</b>     | VAR2012 0013                                                                               | <b>APPLICANT:</b>      | State of Alaska DOT/PF                                |
| <b>TO:</b>           | Adjacent Property Owners                                                                   | <b>PROPERTY OWNER:</b> | State of Alaska                                       |
| <b>HEARING DATE:</b> | July 24, 2012                                                                              | <b>PARCEL NO.:</b>     | N/A                                                   |
| <b>HEARING TIME:</b> | 7:00 PM                                                                                    | <b>ACCESS:</b>         | Egan Drive                                            |
| <b>PLACE:</b>        | ASSEMBLY CHAMBERS<br>Municipal Building<br>155 South Seward Street<br>Juneau, Alaska 99801 | <b>LOCATION:</b>       | Glacier Highway (from<br>McDonalds to the Skate Park) |

## PROPERTY OWNERS PLEASE NOTE:

You are invited to attend this Public Hearing and present oral testimony. The Planning Commission will also consider written testimony. You are encouraged to submit written material to the Community Development Department no later than 8:30 A.M. on the Wednesday preceding the Public Hearing. Materials received by this deadline are included in the information packet given to the Planning Commission a few days before the Public Hearing. Written material received after the deadline will be provided to the Planning Commission at the Public Hearing.

If you have questions, please contact Nicole Jones at 907-586-0218, or e-mail: [nicole\\_jones@ci.juneau.ak.us](mailto:nicole_jones@ci.juneau.ak.us)

Date printed: July 11, 2012

# ATTACHMENT F